



# BUSINESS IS PERSONAL

Your desk phone can drive your digital transformation

**ALE** | Where Everything Connects

- 8078s Cloud Edition DeskPhone
- 8068s Cloud Edition DeskPhone
- 8058s Cloud Edition DeskPhone
- 8018 Cloud Edition DeskPhone
- 8008G Cloud Edition DeskPhone
- 8008 Cloud Edition DeskPhone

## User Manual

8AL90362ENABed0c

## Introduction

Thank you for choosing an Alcatel-Lucent phone.



This model offers enhanced ergonomic features for more effective communication.

This document describes the services offered by the following sets when connected to a SIP server:

- Alcatel-Lucent 8078s Cloud Edition DeskPhone (8078s CE).
- Alcatel-Lucent 8068s Cloud Edition DeskPhone (8068s CE).
- Alcatel-Lucent 8058s Cloud Edition DeskPhone (8058s CE).
- Alcatel-Lucent 8018 Cloud Edition DeskPhone (8018 CE).
- Alcatel-Lucent 8008G Cloud Edition DeskPhone (8008G CE).
- Alcatel-Lucent 8008 Cloud Edition DeskPhone (8008 CE).

Some features described in this document might not work as they also depend on the SIP server to which the Cloud Edition phone is connected. To get the level of features for a given SIP server, please refer to the Release Note for 8008, 8018 and 80x8s Cloud Edition DeskPhones (TC2486), section Compatibility.

The label and icons displayed depend on the type and the skin of the set. The label is not displayed if the corresponding feature is not configured on your telephone system. Depending on the size of the display, some labels may be truncated. *All labels are displayed in color and are italicized.* This icon describes a succession of actions or labels you have to do or select: **➤**.

This icon describes the consequence of an action: **➤➤**.

Some features depend on the type of the set.

	8078s CE	8068s CE	8058s CE	8018 CE	8008G CE	8008 CE
IP Phone	●	●	●	●	●	●
Color screen	●	●	●			
Monochrome screen				●	●	●
Busy light logo on back shell	●	●	●			
Theme (skin)	●	●	●			
Bluetooth® handset	●	●				
Bluetooth® Smart Ready	●	●				
Compatible with Bluetooth ® headset	●	●				
USB headset	●	●	●	●		
Jack headset	●	●	●			
RJ9 headset*					●	●
Wi-Fi dongle compatible	●	●	●	●		
Two-port Gigabit Ethernet switch with Power Over Ethernet support	●	●	●	●	●	
Two-port Fast Ethernet switch with Power Over Ethernet support						●
Premium Add-on 10 keys modules		●	●			
Premium Smart display 14 keys module	●	●	●			
Premium add-on 40-key modules	●	●	●			
Audio services (hands-free, handset and headset)	●	●	●	●	●	●
Adjusting the contrast of the display				●	●	●
Ambient light sensor	●	●	●			
3rd Party Call Control (3PCC)	●	●	●	●	●	●

\*Use an adapter RJ9 to connect a jack or usb headset (3GV28177AA).

The labels and icons presented in this document are not contractually binding and may be modified without prior warning.

<b>1</b>	<b><u>Getting to know your telephone.....</u></b>	<b><u>6</u></b>
1.1	8078s Cloud Edition DeskPhone.....	6
1.2	8068s Cloud Edition DeskPhone.....	8
1.3	8058s Cloud Edition DeskPhone.....	11
1.4	8018 Cloud Edition DeskPhone.....	13
1.5	8008 / 8008g Cloud Edition DeskPhone .....	16
1.6	Permanent features keys.....	18
1.7	Homepage screen .....	19
1.8	Call icons.....	20
1.9	Keyboard.....	20
1.10	Description of the connectors .....	22
1.11	ALE Wideband Bluetooth® Handset.....	23
1.12	ALE Bluetooth® Handset.....	26
1.13	Install a comfort wired handset.....	28
1.14	Multiple SIP accounts.....	28
<b>2</b>	<b><u>Contacts management.....</u></b>	<b><u>29</u></b>
2.1	Local directory .....	29
2.2	Contact card .....	31
<b>3</b>	<b><u>Speed dial management.....</u></b>	<b><u>33</u></b>
3.1	Make call using speed dial .....	33
3.2	Presence .....	33
<b>4</b>	<b><u>Using your telephone.....</u></b>	<b><u>34</u></b>
4.1	Information about the phone .....	34
4.2	Manage the call log .....	34
4.3	Calling by number.....	36
4.4	Making a peer to peer SIP call.....	37
4.5	Calling by name .....	37
4.6	Call from call log.....	38
4.7	Calling using your personal directory.....	38
4.8	Calling using speed dial key.....	38
4.9	Receiving a call .....	39
4.10	Switching between audio modes.....	40
4.11	Activating the loudspeaker during a conversation (handset lifted).....	40
4.12	Redialing .....	40
4.13	Sending DTMF signals.....	41
4.14	Mute, so that your contact cannot hear you .....	41
4.15	Interphony (Auto answer) .....	41
4.16	Lock / unlock your telephone .....	41
4.17	Making a second call during a conversation.....	42
4.18	Answering a second call during a conversation.....	42
4.19	To cancel your second call and recover the first .....	43
4.20	Placing a call on hold (hold) .....	43
4.21	Switching between calls (Broker call) .....	43
4.22	Transferring a call .....	44
4.23	Three-way conference with internal and/or external contacts (conference).....	44
4.24	Five-ways conference with internal contacts - talk simultaneously to more than 2 contacts.....	45
4.25	Hide your phone number .....	45

4.26	Do not disturb .....	45
4.27	Forwarding to a number or voicemail .....	46
4.28	Cancelling all forwards.....	46
4.29	Listen to your voicemail .....	47
4.30	Defining an “hotline” number.....	47
<b>5</b>	<b><u>Make more with your deskphone.....</u></b>	<b>48</b>
5.1	Easy Deployment Server (EDS).....	48
5.2	Configure your phone for teleworking.....	49
5.3	Desk sharing (Hot desking).....	53
5.4	Third-Party Call Control (3PCC).....	53
<b>6</b>	<b><u>Programming your telephone .....</u></b>	<b>54</b>
6.1	Adjusting the audio functions .....	54
6.2	Adjust ringer volume while a call arrives .....	55
6.3	Configuring the welcome page .....	55
6.4	Selecting language .....	55
6.5	Adjusting the contrast of the display (8018 CE, 8008g CE, 8008 CE) .....	55
6.6	Adjusting the brightness of the deskphone (8078s CE, 8068s CE, 8058s CE) .....	56
6.7	Programmable keys (8018 CE, add-on module) .....	57
6.8	install a jack accessory (headset, hands-free, loudspeaker) .....	57
6.9	Install a USB accessory (Headset, Handsfree, Loudspeaker) .....	57
6.10	Install a RJ9 headset (8008g CE, 8008 CE).....	58
6.11	Manage connected devices .....	58
6.12	Manage Bluetooth® device (8078s CE, 8068s CE) .....	59
<b>7</b>	<b><u>Contacting your administrator (technical support).....</u></b>	<b>60</b>
7.1	Technical code / Date code.....	60
7.2	Software version .....	60
7.3	Display network settings .....	60
7.4	Reboot your phone .....	60
7.5	Access to administrator configuration.....	60
<b>8</b>	<b><u>Accessories.....</u></b>	<b>62</b>
8.1	List of accessories .....	62
8.2	8105s EGO .....	64
8.3	8115/8125 Audiooffice.....	67
8.4	USB external ringing interface module (USB Interface module 2 relays 3GV28184AA).....	72
8.5	External ringing interface module (MWS 3GV28050AA).....	74
8.6	Wall mounting kit.....	76
8.7	Connect a 3 pole jack headset .....	79
8.8	Alcatel-Lucent Enterprise Application Partner Program .....	80
<b>9</b>	<b><u>Technical specifications.....</u></b>	<b>81</b>
<b>10</b>	<b><u>Ordering information .....</u></b>	<b>84</b>
<b>11</b>	<b><u>Guarantee and clauses.....</u></b>	<b>85</b>
11.1	Safety Instructions .....	85
11.2	Regulatory Statements .....	86
	<b><u>Quick guide.....</u></b>	<b>87</b>

# 1 Getting to know your telephone

## 1.1 8078s Cloud Edition DeskPhone

This phone is part of the IP phone range. With its 5 inches touch color display, the 8078s Cloud Edition DeskPhone delivers a great user experience and a great conversation comfort with an outstanding wideband audio quality either in hands-free or using the comfort handset. Your experience is additionally improved with its Bluetooth® handset or other Bluetooth® accessories. The 8078s Cloud Edition is 'Bluetooth® Smart Ready'. You can personalize the phone by selecting a theme (skin). It is compatible with teleworking. Consequently, it is perfect for use at your office in your enterprise or at home (teleworking).

### 1.1.1 Phone description



- 1** LED  
Flashing blue: incoming call / appointment alarm.
- 2** Color touchscreen display with auto brightness adjustment which improves the user experience and achieves power savings (ambient light sensor).
- 3** Permanent feature keys: quick access to the phone's main features.
- 4** Bluetooth® wireless handset.
- 5** 3.5 mm, 4 pole jack (TRRS standards: CTIA).
- 6** An adjustable and stable foot.
- 7** Wideband loudspeaker for optimized sound.

### 1.1.2 Main screen and navigation keys

Top bar (date, time, status icons)

Open Menu. display the page by selecting the corresponding tab.

The default homepage shows information about the phone (name, number, number of missed calls, number of new messages, forwarding status).

	Open a page by selecting the corresponding icon in the top bar menu. The selected icon (tab) is highlighted.
	Make your selection by pressing the label or the icon on the screen.
	Scroll a list (features, call log, contact, ...) by pressing the up and down arrow on the screen, or on the keyboard.
	Open options while programming or configuring
	Validate your choice (top bar).
	Use the 'Back/Exit' icon to go back to the previous step (top bar).



 Use this key to delete one number or character at a time.



### 1.1.3 Call management screen

Incoming call icon, Call in progress, call on hold, ...

Incoming call and conversation presentation screen

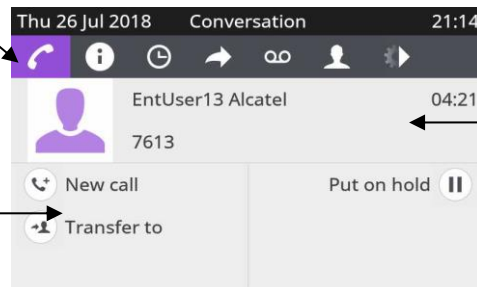

Softkeys: actions available depending on the call status (when presentation screen is not displayed)



-  Select the relevant call icon to display information about the current call, to retrieve a call on hold, to switch between calls.
-  All features are accessible while the call is displayed on the screen. Use the Up and Down arrows to move up or down a page. These functions (transfer, conference, etc.) are directly related to the status of the call consulted. For example, the transfer function will not be available between a call in progress or on hold and an incoming call.

You can select another page, 'consult history' for example, whilst the call is in progress by selecting it on the menu. Retrieve the call management screen by selecting the 'call in progress' icon.

### 1.1.4 Change the theme (skin) of your phone

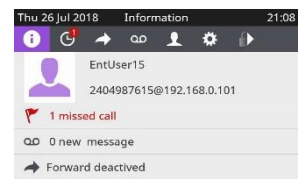

- The phone is in idle state.
-  Select the settings icon from the phone menu (see the navigation section of your phone model).
- Press the keys associated with: *Phone* > *Display* > *Skin*.
- Select the desired new theme from the list (Classical, Rainbow).
- 



Changing the theme may take a few seconds. a corporate theme can be installed by your administrator. in this case, you cannot change the theme. the ringtone settings can be integrated into a theme.

### 1.1.5 Busy light logo on back shell

The logo on back shell can be illuminated. The color changes when you are busy.

- The phone is in idle state.
-  Select the settings icon from the phone menu (see the navigation section of your phone model).
- Press the keys associated with: *Phone* > *Display* > *Busy light*
- Activate or deactivate the logo LED feature.
- 



### 1.1.6 Bluetooth Smart Ready



Your phone is 'Bluetooth® Smart Ready'. It can receive and share Bluetooth® signals from various Bluetooth® devices (Bluetooth® and Bluetooth® Smart or Low-energy devices). It is ready for future services available on the fly in a subsequent software upgrade. This feature can be deactivated by the administrator.

## 1.2 8068s Cloud Edition DeskPhone

This phone is part of the IP phone range. With its color display associated to 10 dedicated functions keys, and an intuitive navigation key, the 8068s Cloud Edition DeskPhone delivers a great user experience and great conversation convenience with an outstanding audio quality in either hands-free mode or using the comfort handset. Your experience is additionally improved with its Bluetooth® handset or other Bluetooth® accessories. It is 'Bluetooth® Smart Ready'. You can personalize the phone by selecting a theme (skin). It is compatible with teleworking. Consequently, it is perfect for use at your office in your enterprise or at home (teleworking).

### 1.2.1 Phone description



- 1 LED  
Flashing blue: incoming call / appointment alarm.  
Color display with auto brightness adjustment which enhances user experience and saves power (ambient light sensor).
- 2 10 dedicated functions keys.
- 3 Navigation.
- 4 Permanent feature keys: quick access to the phone's main features.
- 5 Bluetooth® wireless handset.
- 6 Wired handset.
- 7 3.5 mm, 4 pole jack (TRRS standards: CTIA).
- 8 An adjustable and stable foot.
- 9 Wideband loudspeaker for optimized sound.

### 1.2.2 Main screen and navigation keys

Top bar (date, time, status icons)

Open Menu.  
display the page by selecting  
the corresponding tab.

Thu 26 Jul 2018
21:00

Clara

2404987613@192.168.0.102

📞 1 missed call

✉️ 0 new message

➡️ Forward deactivated

The default homepage shows information about the phone (name, number, number of missed calls, number of new messages, forwarding status).



**Right navigator:**  
Open the menu to access features for configuring the phone or managing calls.

**OK key:**  
use this key to validate your choices and options while programming or configuring (short press). Used to access features for managing the call log such as delete a log, delete all logs, display missed calls only and acknowledge missed calls (in idle state).



**Left-right navigator:**  
used to move from one page to another and display information about current calls (call in progress, calls on hold, incoming call).

**Up-down navigator:**  
when information extends over more than one page, use the down navigation key to display the next page. Use the up navigation key to display the previous page.

**Back/Exit key:**  
Use this key to go back to the previous step.  
Use this key to delete one number or character at a time.



### 1.2.3 Call management screen



-  Each tab corresponds to a call, the status of which is symbolized by its icon (in progress, call on hold, arrival of new call). When a call is in progress, use the left-right navigator to look at calls on hold or incoming calls.
-  All features are accessible while the call is displayed on the screen. Use the Up and Down arrows to move up or down a page. These functions (transfer, conference, etc.) are directly related to the status of the call consulted. For example, the transfer function will not be available between a call in progress or on hold and an incoming call.
-  Press the key in front of the label to select the corresponding feature.

You can select another page, 'consult history' for example, whilst the call is in progress by selecting it on the menu. Retrieve the call management screen by selecting the 'call in progress' icon.

## 1.2.4 Change the theme (skin) of your phone



- The phone is in idle state.
-  Select the settings icon from the phone menu (see the navigation section of your phone model).
- Press the keys associated with: *Phone* › *Display* › *Skin*.
- Select the desired new theme from the list (Classical, Rainbow).
- 



Changing the theme may take a few seconds.

## 1.2.5 Busy light logo on back shell

The logo on back shell can be illuminated. The color changes when you are busy.

- The phone is in idle state.
-  Select the settings icon from the phone menu (see the navigation section of your phone model).
- Press the keys associated with: *Phone* › *Display* › *Busy light*
- Activate or deactivate the logo LED feature.
- 



## 1.2.6 Bluetooth Smart Ready



Your phone is 'Bluetooth® Smart Ready'. It can receive and share Bluetooth® signals from various Bluetooth® devices (Bluetooth® and Bluetooth® Smart or Low-energy devices). It is ready for future services available on the fly in a subsequent software upgrade. This feature can be deactivated by the administrator.

### 1.3 8058s Cloud Edition DeskPhone

This phone is part of the IP phone range. With its color display associated to 10 dedicated functions keys, and an intuitive navigation key, the 8058s Cloud Edition DeskPhone delivers a great user experience and great conversation convenience with an outstanding audio quality in either hands-free mode or using the comfort handset. It provides high audio fidelity for telephone calls either in hands-free mode or using the comfort handset. You can personalize the phone by selecting a theme (skin). It is compatible with teleworking. Consequently, it is perfect for use at your office in your enterprise or at home (teleworking).

#### 1.3.1 Phone description



- 1 LED  
Flashing blue: incoming call / appointment alarm.  
Color display with auto brightness adjustment which enhances user experience and saves power (ambient light sensor).
- 2 10 dedicated functions keys.
- 3 Navigation.
- 4 Permanent feature keys: quick access to the phone's main features.
- 5 Wired handset.
- 6 3.5 mm, 4 pole jack (TRRS standards: CTIA).
- 7 An adjustable and stable foot.
- 8 Wideband loudspeaker for optimized sound.

#### 1.3.2 Main screen and navigation keys

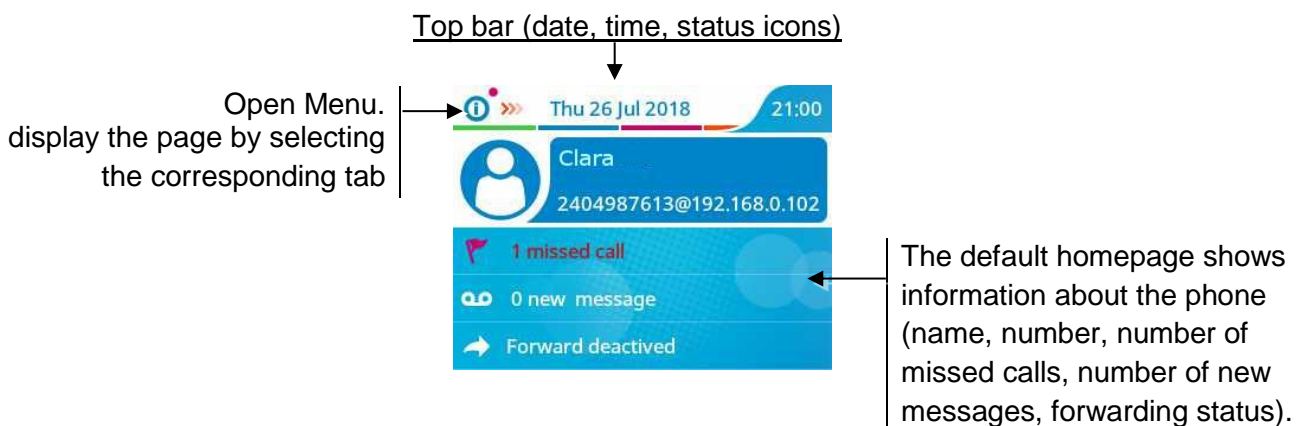

**Right navigator:**

Open the menu to access features for configuring the phone or managing calls.

**OK key:**

use this key to validate your choices and options while programming or configuring (short press). Used to access features for managing the call log such as delete a log, delete all logs, display missed calls only and acknowledge missed calls (in idle state).

**Left-right navigator:**

Used to move from one page to another and display information about current calls (call in progress, calls on hold, incoming call).



**Up-down navigator:**

When information extends over more than one page, use the down navigation key to display the next page. Use the up navigation key to display the previous page.



**Back/Exit key:**

Use this key to go back to the previous step.  
Use this key to delete one number or character at a time.

**1.3.3 Call management screen**

Incoming call icon, Call in progress, Call on hold, ...

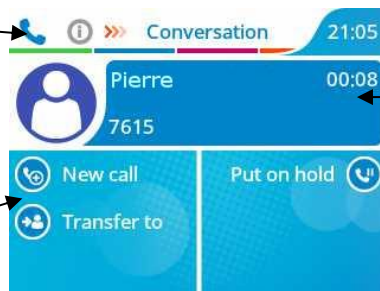

Incoming call and conversation presentation screen

Softkeys: actions available depending on the call status (when presentation screen is not displayed)



Each tab corresponds to a call, the status of which is symbolized by its icon (in progress, call on hold, arrival of new call). When a call is in progress, use the left-right navigator to look at calls on hold or incoming calls.





All features are accessible while the call is displayed on the screen. Use the Up and Down arrows to move up or down a page. These functions (transfer, conference, etc.) are directly related to the status of the call consulted. For example, the transfer function will not be available between a call in progress or on hold and an incoming call.



Press the key in front of the label to select the corresponding feature.

You can select another page, 'consult history' for example, whilst the call is in progress by selecting it on the menu. Retrieve the call management screen by selecting the 'call in progress' icon.

**1.3.4 Change the theme (skin) of your phone**

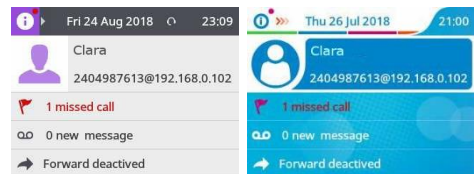

- The phone is in idle state.
-  Select the settings icon from the phone menu (see the navigation section of your phone model).
- Press the keys associated with: *Phone* › *Display* › *Skin*.
- Select the desired new theme from the list (Classical, Rainbow).
- 



Changing the theme may take a few seconds.

### 1.3.5 Busy light logo on back shell

The logo on back shell can be illuminated. the color changes when you are busy.

- The phone is in idle state.
-  Select the settings icon from the phone menu (see the navigation section of your phone model).
- Press the keys associated with: *Phone* > *Display* > *Busy light*
- Activate or deactivate the logo LED feature.
- 



## 1.4 8018 Cloud Edition DeskPhone

This phone is part of the IP phone range. In addition to a clear monochrome display associated to 6 dedicated function keys and an intuitive navigation key, the 8018 Cloud Edition DeskPhone provides 4 programmable keys as a smart add-on module, for a quick access to your favorite contacts or features. It provides high audio fidelity for telephone calls either in hands-free mode or using the comfort handset. It is compatible with teleworking. Consequently, it is perfect for use at your office in your enterprise or at home (teleworking).

### 1.4.1 Phone description



- 1 LED  
Flashing blue: incoming call / appointment alarm.
- 2 Monochrome screen.
- 3 6 dedicated functions keys.  
3 preprogrammed keys with Led and paper icon:  
4 Alpha-numeric key, F1, F2.  
4 programmable keys with Led and paper label.
- 5 Navigation.
- 6 Permanent feature keys: quick access to the phone's main features.
- 7 Wired handset.
- 8 USB connector for headset.
- 9 Stable foot.
- 10 Loudspeaker.

Your phone has 4 programmable keys with led and paper label. These keys are used to program a direct call. You can use the paper to describe the key.



### 1.4.2 Main screen and navigation keys

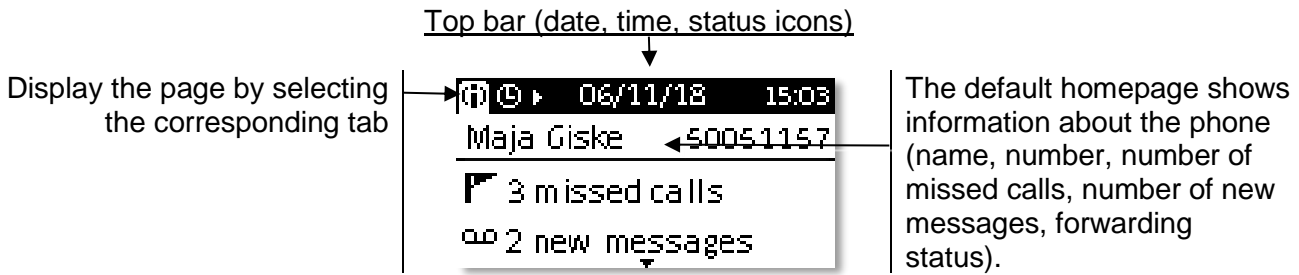

**Right navigator:**  
Open the menu to access features for configuring the phone or managing calls.

**OK key:**  
use this key to validate your choices and options while programming or configuring (short press). Used to access features for managing the call log such as delete a log, delete all logs, display missed calls only and acknowledge missed calls (in idle state).

**Left-right navigator:**  
Used to move from one page to another and display information about current calls (call in progress, calls on hold, incoming call).

**Up-down navigator:**  
When information extends over more than one page, use the down navigation key to display the next page. Use the up navigation key to display the previous page.

**back/Exit key:**  
Use this key to go back to the previous step.  
Use this key to delete one number or character at a time.

### 1.4.3 Call management screen

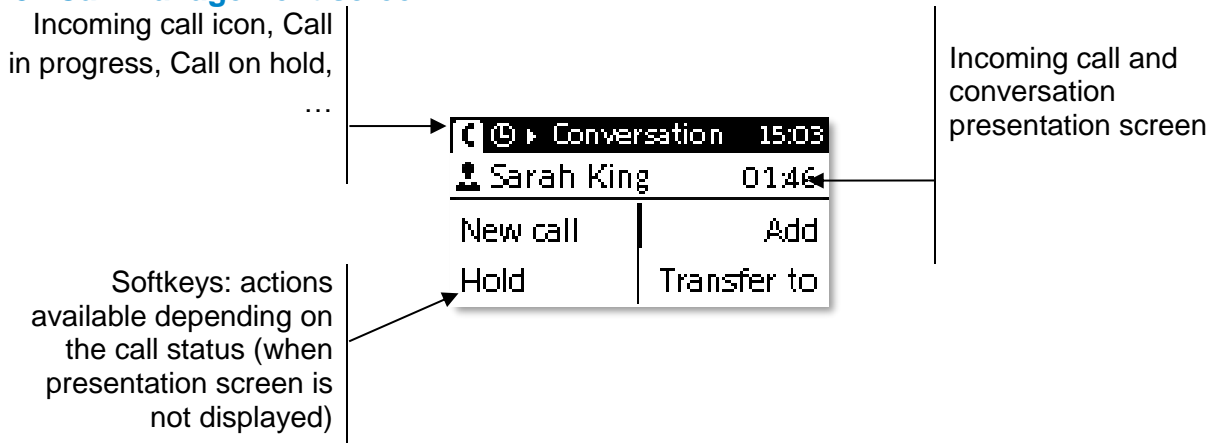

- Each tab corresponds to a call, the status of which is symbolized by its icon (in progress, call on hold, arrival of new call). When a call is in progress, use the left-right navigator to look at calls on hold or incoming calls.
- All features are accessible while the call is displayed on the screen. Use the Up and Down arrows to move up or down a page. These functions (transfer, conference, etc.) are directly related to the status of the call consulted. For example, the transfer function will not be available between a call in progress or on hold and an incoming call.
- Press the key in front of the label to select the corresponding feature.

You can select another page, 'consult history' for example, whilst the call is in progress by selecting it on the menu. Retrieve the call management screen by selecting the 'call in progress' icon.

## 1.4.4 Changing or updating the paper label

### Removing the paper label

- Lift the protective cover at the notch and slide it up to take it out of its housing.
- Remove the paper label in the same way.
- Update or replace the paper label.

### Inserting the phone label

- Insert the paper label from the top end, making sure it is placed correctly behind the notches.
- Put the protective cover back in the same way.



## 1.4.5 Function keys and programmable keys



Your phone uses 3 pre-programmed keys to access certain features. In this case, the icon of the feature is printed on the paper. Use the feature by pressing the corresponding key. When activated, the LED corresponding to the key remains lit up. Press the corresponding key to deactivate it.

- **123<->abc** Alpha-numerical keypad.  
Use this key to switch between alphabetic keyboard and numeric keyboard.
- **F** The F1 and F2 keys are line keys.

The application 'LabelSet' is available to help you to print the paper labels. Please contact your business partner for more information.

## 1.5 8008 / 8008G Cloud Edition DeskPhone

This phone is part of the IP phone range. In addition to a clear monochrome display with six dedicated function keys and an intuitive navigation key, the 8008 Cloud Edition DeskPhone provides high audio fidelity for telephone calls either in hands-free mode or using the comfortable handset. It is compatible with teleworking. Consequently, it is perfect for use at your office in your enterprise or at home (teleworking). The phone is available in two versions: 8008 Cloud Edition, 8008G Cloud Edition. The 8008G Cloud Edition is equipped with a monochrome backlit screen and a gigabit ethernet connection.

### 1.5.1 Phone description

- 1 8008 CE: monochrome screen.  
8008G CE: monochrome backlit screen. LED
- 2 Flashing blue: incoming call / appointment alarm.
- 3 6 dedicated functions keys.
- 4 Navigation, ok and cancel keys.
- 5 3 preprogrammed keys with LEDs: Alpha-numeric key, F1, F2.
- 6 Messaging key to access various mail services.
- 7 Mute and interphony key.
- 8 Audio feature keys.
- 9 Redial key.
- 10 Loudspeaker.
- 11 Wired handset.
- 12 Stable foot.

A corded headset can be connected via RJ9 connector.

### 1.5.2 Main screen and navigation keys

Top bar (date, time, status icons)

06/11/18 15:03  
 Maja Giske ← 50051157  
 3 missed calls  
 2 new messages

The default homepage shows information about the phone (name, number, number of missed calls, number of new messages, forwarding status).

Display the page by selecting the corresponding tab.

**Right navigator:**  
Open the menu to access features for configuring the phone or managing calls.

**OK key:**  
use this key to validate your choices and options while programming or configuring (short press). Used to access features for managing the call log such as delete a log, delete all logs, display missed calls only and acknowledge missed calls (in idle state).

**Left-right navigator:**



Used to move from one page to another and display information about current calls (call in progress, calls on hold, incoming call).

**Up-down navigator:**

When information extends over more than one page, use the down navigation key to display the next page. Use the up navigation key to display the previous page.



**Back/Exit key:**

Use this key to go back to the previous step.  
Use this key to delete one number or character at a time.

**1.5.3 Call management screen**

Incoming call icon, Call in progress, Call on hold, ...



Incoming call and conversation presentation screen

Softkeys: actions available depending on the call status (when presentation screen is not displayed)



Each tab corresponds to a call, the status of which is symbolized by its icon (in progress, call on hold, arrival of new call). When a call is in progress, use the left-right navigator to look at calls on hold or incoming calls.



All features are accessible while the call is displayed on the screen. Use the Up and Down arrows to move up or down a page. These functions (transfer, conference, etc.) are directly related to the status of the call consulted. For example, the transfer function will not be available between a call in progress or on hold and an incoming call.



Press the key in front of the label to select the corresponding feature.

You can select another page, 'consult history' for example, whilst the call is in progress by selecting it on the menu. Retrieve the call management screen by selecting the 'call in progress' icon.

**1.5.4 Function keys and programmable keys**



























Your phone uses 3 pre-programmed keys to access certain features. In this case, the icon of the feature is printed on the paper. Use the feature by pressing the corresponding key. When activated, the LED corresponding to the key remains lit up. Press the corresponding key to deactivate it.

- **123<>abc** Alpha-numerical keypad  
Use this key to switch between alphabetic keyboard and numeric keyboard.
- **F** The F1 and F2 keys are line keys.

## 1.6 Permanent features keys

they are located just above the loudspeaker. Feature keys depend on the type of phone.

8078s CE 8068s CE 8058s CE	8018 CE	8008 CE 8008G CE	Description
			<ul style="list-style-type: none"> <li>Mute key During a call, press this key to stop your contact from hearing you.</li> </ul>
			<ul style="list-style-type: none"> <li>Turn down the volume (ringing or call state).</li> <li>Decrease the brightness (idle state).</li> <li>Decrease the contrast (idle state).</li> </ul>
			<ul style="list-style-type: none"> <li>Turn up the volume (ringing or call state).</li> <li>Increase the brightness (idle state).</li> <li>Increase the contrast (idle state).</li> </ul>
			<ul style="list-style-type: none"> <li>Pressing this key answers an incoming call in hands-free mode (when activated, the key is lit blue). When a call is in progress, pressing this key switches from hands-free mode to headset or handset mode.</li> </ul>
			<ul style="list-style-type: none"> <li>The F1 and F2 keys are line keys.</li> </ul>
			<ul style="list-style-type: none"> <li>Last number redial. For the phones 8018/8008G/8008 Cloud Edition DeskPhone, the redial key is associated with the Off-hook key when the phone is in idle state: .</li> </ul>
			<ul style="list-style-type: none"> <li>Information about the user: lastname, firstname, phone number,.. (short press).</li> <li>Switch between the alphabetic and numeric keyboards (long press).</li> </ul>
			<ul style="list-style-type: none"> <li>Switch between the alphabetic and numeric keyboards (short press).</li> <li>Information about the user: lastname, firstname, phone number,.. (long press).</li> </ul>
			<ul style="list-style-type: none"> <li>Access the voice mail The message key flashes when you have received a new voicemail.</li> </ul>



















## 1.7 Homepage screen

The homepage is the default page displayed on your phone. The default homepage shows information about the phone (name, number, number of missed calls, number of new messages, forwarding status), but this can be changed in the phone settings.













Depending on the type of your phone, you can navigate in the title bar by pressing on it or by using the right navigation key. Icons depend on the theme (skin) of the phone.

		Display all information about the phone: name, number, number of missed calls, number of new messages, forwarding status. The icon is marked with a red dot if there is one or more new event.
		Access to the calls log. The number of new events are displayed (number of missed calls + number of unread messages).
		Access the forwarding configuration.
		access the voicemail. The number of new voice messages is displayed. The number of new voice messages is displayed.
		Access the local directory.
		Access the settings.
		Lock/unlock the phone.
		Access to personal speed dial.

## 1.8 Call icons



Icons giving information about some specific configurations of the phone or about call status are displayed in the top bar of the screen. Icons depend on the theme (skin) of the phone.





		Incoming call icon. This icon blinks when there is another incoming call.
		Call in progress icon.
		Call holding icon. This icon blinks when there is another ongoing call.
		Conference icon.
		End of call icon. Your contact ended the conversation.



## 1.9 Keyboard

### 1.9.1 Alpha-numeric keyboard

Your phone is equipped with alphanumeric keyboard. You can switch between numeric keyboard to dial number, and alphabetic keyboard to enter text by pressing the corresponding preprogrammed key.

- Depending on the phone type, you can switch between the alphabetic and numeric keyboards by pressing the following key:
  -  (long press): when the alphabetic mode is activated, this icon is displayed in the top bar of the screen: .
  -  (short press): when the alphabetic mode is activated, the light corresponding to the key remains lit up.
- Enter alphabetic characters.  
The number pad keys have letters that you can display by successive presses. The number is the last character in the series. Some special characters can be displayed by successively pressing the key:

	% \$ / ~ & ( ) [ ] = *
	@ #
	space - _ 1
	+ . , ; : / \ ? ! 0

-  Use navigation keys to move the cursor into the text.
-  Use this key to delete the last entered character. The alphabetic mode remains activated.
- Select the lit preprogrammed key to return to the numeric mode.

### 1.9.2 Magnetic alphabetic keyboard (optional)

Adding a magnetic alphabetic keyboard to your phone increases its performance. This accessory is sold separately from the deskphone. The keyboard depends on your country and languages. The magnetic keyboard is automatically fixed on the base of the set. It is connected to the corresponding connector behind the phone.



- Country variants:
  - AZERTY
  - QWERTZ
  - QWERTY (international)
  - QWERTY (nordic)

Use the keyboard to enter names while configuring the phone. Access directly access the dial by name feature by entering the name of your contact on the keyboard.

Below is a list of the function keys that allow you to access all the symbols.

	Cursor moving keys (left, right, up and down). Allows you to navigate edit boxes. Press the Alt key to access the left and up directions.
	Caps lock: to write text in capital letters.
	Alt key: to access specific and punctuation characters.
	Enter key: to validate edited text.
	Backspace key: to delete one character in an edit box.

### 1.10 Description of the connectors

Various connections to allow phone extensions. The type of connectors you have depends on your phone.

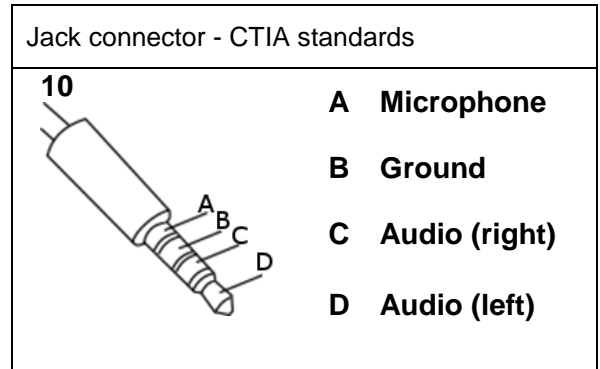
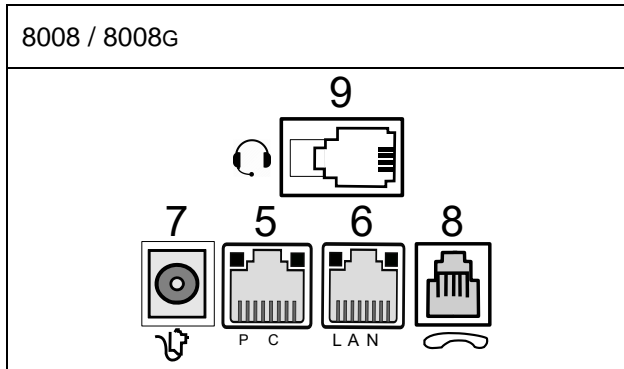
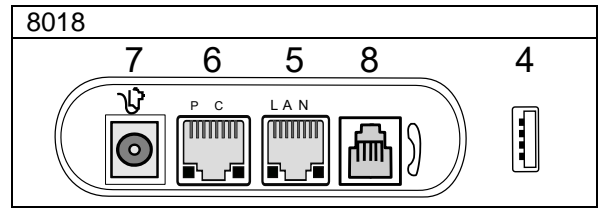
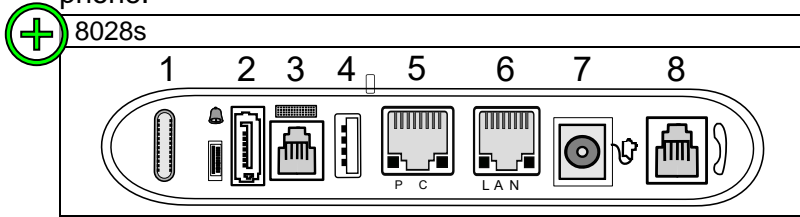

		8078s CE	8068s CE	8058s CE	8018 CE	8008G CE	8008 CE
1	Universal Serial Bus (USB-c) connector	●	●	●			
2	Add-on module/external ringing connector (SATA type).	●	●	●			
3	Magnetic alphanumeric keyboard connector (RJ 9).	●	●	●			
4	Universal Serial Bus (USB-a) connector. The use of this connector depends on the model of your deskphone. For example, this connector can be used for: audio equipment, a low-energy smartphone charger, USB stick, Bluetooth® USB dongle provided with a Bluetooth® headset, wifi dongle, beacon dongle or an external ringing module. For the 8018 DeskPhone, the USB connector is on the side of the deskphone.	●	●	●	●		
5	10/100/1000 Mbps Ethernet connectors to a PC (RJ45).	●	●	●	●	●	
	10/100 Fast Ethernet connector (PC).						●
6	10/100/1000 Mbps Ethernet connectors to the enterprise network (LAN - RJ45).	●	●	●	●	●	
	10/100 Fast Ethernet connector (LAN).						●
7	DC power jack for an external power adaptor.	●	●	●	●	●	●
8	Wired handset connector (RJ9).	●	●	●	●	●	●
9	RJ9 connector for a corded headset.					●	●
10	3.5 mm, 4 pole jack (TRRS standards: CTIA).	●	●	●			

### 1.11 ALE Wideband Bluetooth® Handset

The Bluetooth® Wireless handset is only available with compatible Bluetooth® deskphones.

	8078s CE	8068s CE	8058s CE	8018 CE	8008/8008G CE
ALE Wideband Bluetooth® Handset	●	●			

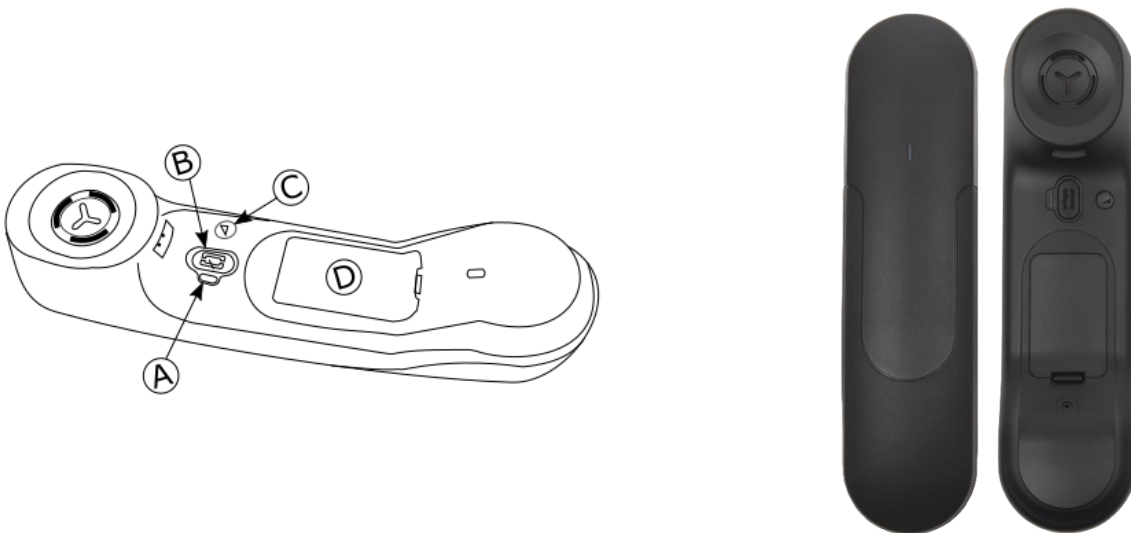

	<p><b>LED</b> (front and back of the device)</p> <ul style="list-style-type: none"> <li>LED off: the handset is charging on its base or is switched off. When you put the handset on its base, the LED turns blue briefly and turns off again when the battery starts to charge.</li> </ul>
A	<ul style="list-style-type: none"> <li>Blue flashing: normal operation.</li> <li>Red slow flashing: battery charge low. If voice prompts are enabled, you hear: "Battery low".</li> <li>Red fast flashing: handset outside coverage zone. If voice prompts are enabled, you hear: "Out of Range".</li> <li>Red steady: handset not paired.</li> </ul>
B	<p><b>Line key</b></p> <ul style="list-style-type: none"> <li>Switch the device on/off: press and hold to switch the device on/off. If voice prompts are enabled, you hear: "Power On / Power Off".</li> <li>Off-hook/On-hook: press this key to take or terminate a call.</li> <li>Voice prompts (in idle state): double press to enable the voice prompt.</li> </ul>
C	<p><b>Volume/Mute key</b></p> <ul style="list-style-type: none"> <li>Volume (during conversation): press in quick succession to change the handset volume level.</li> <li>Mute (during conversation): press and hold to ensure your correspondent no longer hears you.</li> <li>Voice prompts (in idle state): double press to disable the voice prompt.</li> </ul>
D	<ul style="list-style-type: none"> <li>Location of the battery.</li> </ul>

If the Bluetooth® handset is on its base, you do not need to press the Off-hook/On-hook key to take or terminate the call. Just off-hook/on-hook the Bluetooth® handset

The battery recharges when the Bluetooth® handset is on its base. When you put the handset on its base, the LED turns on briefly and turns off again when the battery starts to charge. The battery autonomy is more than 10 hours in conversation, and 50 hours in idle state. Charge the battery for about 6 hours before initial use.



If you are not going use the handset for a long time, we recommended that you switch off the device by using the switch at the top of the battery compartment

### 1.11.1 Voice prompts

The voice prompts help you to manage functions of the handset. Voice prompts are available in 5 languages. The default language is English. To hear the prompt, the handset has to be near your ear. To select the next language, with the handset turned on, double press the 2 keys of the handset (B,C) at the same time. You hear the new selected language. Repeat until the desired language is reached. To disable the voice prompts, with the handset turned on, double press the Volume/mute key (C). You are notified with a long beep. To enable the voice prompts, with the handset turned on, double press the Line key (B). You are notified with 2 short beeps.

### 1.11.2 Installing or replacing the Bluetooth® handset battery

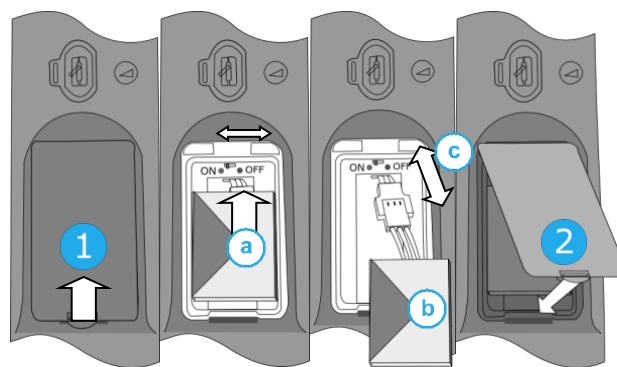

During the first use, to activate the battery, you have to set the switch to ON:

- 1- Lift up the battery cover.
  - a. Set the switch at the top of the compartment to ON using a pencil point.
- 2- Put the cover back on. Take care not to damage the cables when you put the cover on.

To replace the battery, with the handset turned off:

- 1- Lift up the battery cover.
  - a. Set the switch at the top of the compartment to OFF using a pencil point.
  - b. Lift up the battery using the tab to help you.
  - c. Disconnect the old battery and replace it with the new one by joining the 2 connectors. Arrange the battery, the cable and the connectors in the compartment.
  - a. Set the switch at the top of the compartment to ON using a pencil point.
- 2- Put the cover back on. Take care not to damage the cables when you put the cover on.

A spare battery can be ordered from your business partner.

### 1.11.3 Pairing and connecting the Bluetooth® wireless handset

This feature is only available with compatible Bluetooth® deskphone. Otherwise the corresponding menu is not displayed or is inactive.

Before the Bluetooth® handset can be used, it must be correctly paired to the terminal. Pairing will create a wireless link between the Bluetooth® wireless handset and the deskphone.

1- Set your deskphone to 'discover' the Bluetooth® wireless handset

-  Select the settings icon from the phone menu (see the navigation section of your phone model).
- Press the keys associated with: *Phone* > *Bluetooth®* > *Add device*.  
>> scanning starts.

2- Put the handset in detectable mode

- With the handset turned on, press and hold the 2 Bluetooth® handset keys (B, C) at the same time. If voice prompts are enabled, you hear: "Pairing mode, waiting for connection" ».

3- Connect the handset with the deskphone

- Searching for Bluetooth® equipment. Wait for the detected equipment type and address to be displayed.
- Select the Bluetooth® wireless handset displayed in your deskphone: "ALE BT WB Handset".
- Add the device by selecting the relevant menu on your deskphone (depending on the deskphone).
- If voice prompts are enabled, you hear: "Device connected". The 3-note tone indicates that the handset has been installed correctly. The LED flashes blue or red depending on the battery charge level.

The handset is correctly connected if it appears in the list of connected devices on your deskphone (see user manual of the deskphone). Press the Line key of the handset to test the connection, your deskphone prompts you to enter a number. Please contact your installer if you encounter any problems. Before contacting your installer make sure you have information such as the serial number, the date code and the technical reference that you can find on the battery.

### 1.12ALE Bluetooth® Handset

The Bluetooth® Wireless handset is only available with compatible Bluetooth® deskphones.

	8078s CE	8068s CE	8058s CE	8018 CE	8008/8008G CE
ALE Bluetooth® Handset	●	●			

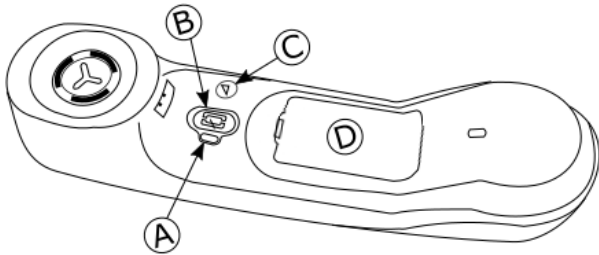

A	<p><b>LED</b> (front and back of the device)</p> <ul style="list-style-type: none"> <li>Off: operating normally.</li> <li>Green flashing: in communication.</li> <li>Green steady: handset charging.</li> <li>Orange flashing: battery charge low or handset outside coverage zone.</li> <li>Orange steady: malfunction</li> </ul>
B	<p><b>Line key</b></p> <ul style="list-style-type: none"> <li>Switch the device on/off: press and hold to switch the device on/off.</li> <li>Off-hook/On-hook: press this key to take or terminate a call.</li> </ul>
C	<p><b>Volume/Mute key</b></p> <ul style="list-style-type: none"> <li>Volume (during conversation): short successive presses to change the handset volume level (3 levels).</li> <li>Mute (during conversation): long press to activate or deactivate mute mode.</li> </ul>
D	<ul style="list-style-type: none"> <li>Location of the battery.</li> </ul>

If the Bluetooth® handset is on its base, you do not need to press the Off-hook/On-hook key to take or terminate the call. Just off-hook/on-hook the Bluetooth® handset.

### 1.12.1 Installing or replacing the Bluetooth® handset battery

At the first use, you have to connect the battery to the handset. The battery is placed in its compartment but it is not connected. To install a new battery, follow instruction:

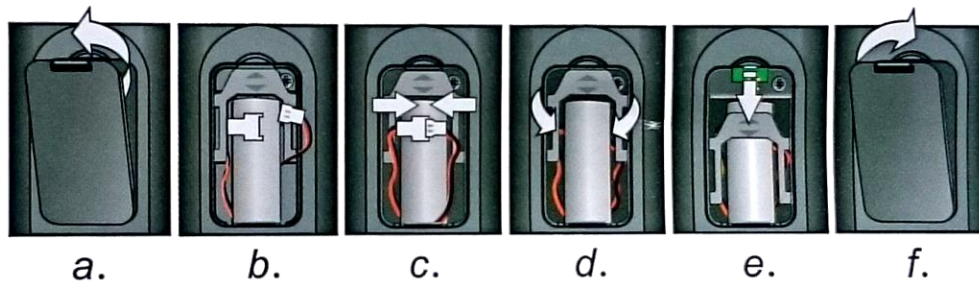

- a) Lift up the battery cover.
- b) Take the 2 connectors.
- c) Assemble the 2 connectors.
- d) Arrange the battery, the cable and the connectors in the battery compartment (place the connected side of the battery in the bottom of the compartment)
- e) Slide out the battery holding part.
- f) Replace the cover.

The battery recharges when the Bluetooth® handset is on its base.

Switch on / off the Bluetooth® handset: long press on the off-hook/on-hook key.

Defective batteries must be returned to a collection point for chemical waste disposal.

### 1.12.2 Pairing and connecting the Bluetooth® wireless handset

This feature is only available with compatible Bluetooth® deskphone. Otherwise the corresponding menu is not displayed or is inactive.

Before the Bluetooth® handset can be used, it must be correctly paired to the terminal.

#### 1- Set your deskphone to 'discover' the Bluetooth® wireless handset

-  Select the settings icon from the phone menu (see the navigation section of your phone model).
- Press the keys associated with: *Phone* › *Bluetooth®* › *Add device*.
- **>>** scanning starts.

#### 2- Put the handset in detectable mode

-  Keeping the handset turned off, press and hold the 2 Bluetooth® handset keys (B, C) at the same time. You will hear a 3 note signal and the LED will flash green and orange alternately.

#### 3- Connect the handset with the deskphone

- Searching for Bluetooth® equipment. Wait for the detected equipment type and address to be displayed.
- Select the Bluetooth® wireless handset displayed in your deskphone: "IC Touch handset".
- Add the device by selecting the relevant menu on your deskphone (depending on the deskphone).

If a PIN code is requested:

- Enter the PIN Code.
- *Confirm*
- A tone indicates that the handset has been installed correctly. The LED flashes green or orange depending on the battery charge level.
-  Go back to the Homepage.

## Error messages

- The Bluetooth® handset emits a sequence of 4 beeps: your set is an older generation than your Bluetooth® handset.
- The set displays an error message indicating that the set and the Bluetooth® handset are incompatible: your Bluetooth® handset is an older generation than your set.

### 1.13 Install a comfort wired handset

- Remove the rubber.
- Plug-in the wired handset to the appropriate connector (refer to phone description).
- Make sure you position the cable correctly in the compartment intended for that purpose.

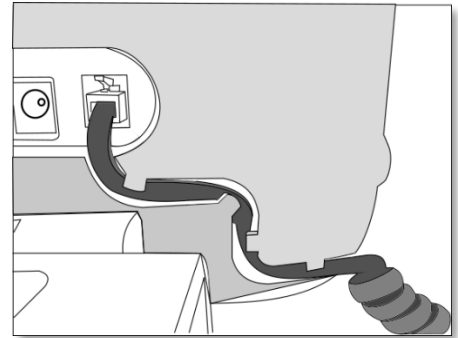

### 1.14 Multiple SIP accounts

Your phone supports multiple SIP accounts:

- 8008/8008G CE, 8018 CE: 1 main SIP account and 1 secondary SIP account
- 8078s CE, 8058s CE, 8068s CE: 1 main SIP account and 3 secondary SIP accounts

A main SIP account manages all features of the phone. All incoming calls are managed as defined with the main account. Incoming calls of each account are received on the same phone. The SIP account that receives the call is displayed on the phone.

By default the main account is used to make outgoing calls but you can choose a secondary SIP account to make the call.



The call log lists all incoming and outgoing calls for all SIP accounts. The concerned SIP account is displayed for each entry of the call log.





## 2 Contacts management

### 2.1 Local directory







Your phone lets you manage contacts in your local directory.

-  Select the local directory icon from the phone menu (see the navigation section of your phone model).
- Depending on your phone, select the following key:
  -  Press the menu key at the right top of the screen (8078s CE).
  -  Press ok key to open menu.

	<i>New</i>	Create a new contact.
	<i>Delete</i>	Delete the selected contact.
	<i>Delete all</i>	Delete all contacts in the local directory.

#### 2.1.1 Create a new contact

If your local directory is empty, press the ok key to add a new contact.









-  Select the local directory icon from the phone menu (see the navigation section of your phone model).
- Depending on your phone, select the following key:
  -  Press the menu key at the right top of the screen (8078s CE).
  -  Press ok key to open menu.
-  *New*
- Fill in the contact file.  
You must provide at least a last name.
-  Choose a predefined avatar.
-  or 
- Your contact is added to the directory.

Other method:







- Add a contact from the call log (see: contact card).
- Search for a contact in a corporate directory and add the selected contact in your local directory (see: contact card).

For external numbers, we recommend you use canonical address formats comprising '+', followed by the country code (e.g. '33') then the number without the first digit. For example, for 0390670000, enter the number +3390670000. To get the '+' sign, long press on the '0' key. This example is for calling a number in France from another country.







## 2.1.2 Delete a contact

-  Select the local directory icon from the phone menu (see the navigation section of your phone model).
- Use one of the following:
  - Open the contact card by selecting the avatar (left side):  .
  -  Navigate between pages to reach the list of actions (consecutive presses).
  -  *Delete*
  - Depending on your phone, select the following key:
    -  Press the menu key at the right top of the screen (8078s CE).
    -  Press ok key to open menu.
  -  *Delete*: All contacts are listed.
  -  Press the delete icon for the contact to delete the corresponding contact.

## 2.1.3 Delete all contacts in the local directory

-  Select the local directory icon from the phone menu (see the navigation section of your phone model).
- Depending on your phone, select the following key:
  -  Press the menu key at the right top of the screen (8078s CE).
  -  Press ok key to open menu.
-  *Delete all*
-  or 

## 2.1.4 Modify a contact

-  Select the local directory icon from the phone menu (see the navigation section of your phone model).
- Open the contact card by selecting the avatar (left side):  .
-  Navigate between pages to reach the list of actions.
-  *Edit*
- Fill in the contact file. You must provide at least a last name.
-  or 

## 2.2 Contact card

Open the contact card by selecting the avatar (left side): . A contact card can be opened from your conversation history, the local directory or from the search result.

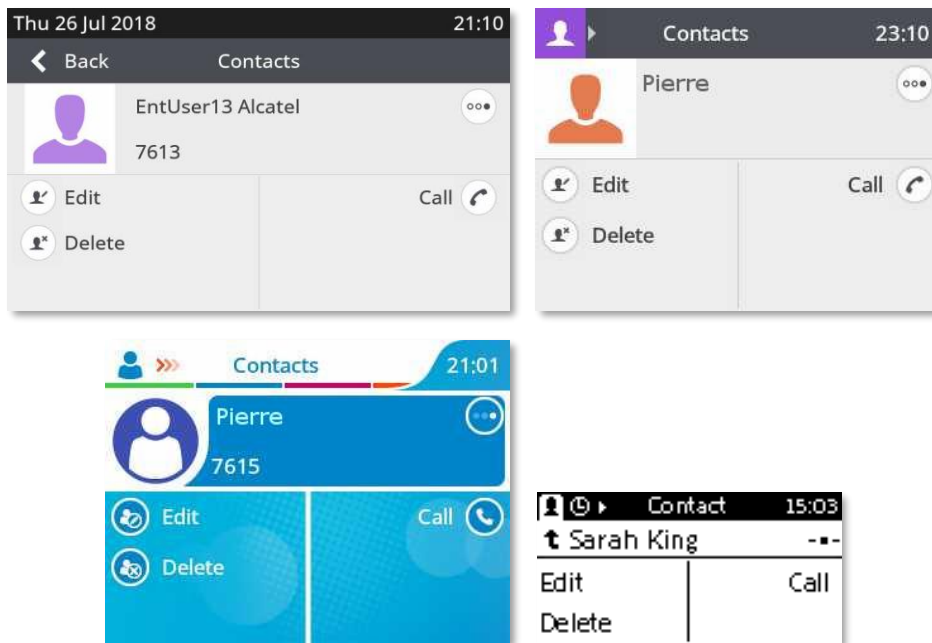







A card contains 3 pages:







- Your conversation history with this contact.
- Main information about your contact (photo, phone number, email).
- Action proposed with this contact (call, add to local directory).

When you open the contact card, the conversation history is displayed if there are one or more new events, otherwise the action page is displayed.

The actions available depend on where your contact card is opened from (history, local directory, etc.).



	...	Navigate between different pages.
	<i>Call</i>	Call the contact.
	<i>Add</i>	Add the contact to your local directory (if the contact is not already saved here).
	<i>Edit</i>	Modify the contact.
	<i>Delete</i>	Delete the contact from your local directory.
		Go back to the Homepage.

## 2.2.1 Add the contact to your local directory

-  Select the history icon from the phone menu (see the navigation section of your phone model).
-  Open the contact card of the contact you want to add to your local directory.
-  *Add*
- Fill in the contact file.  
You must provide at least a last name.
-  Choose a predefined avatar.
-  or 
- Your contact is added to the directory.

## 2.2.2 Company directory (LDAP)

This feature is available if a company directory is configured in your system.



-  Enter the first letters of your contact's name.
- The search history is displayed.
- Enter the first letters of your contact's name.
- The search runs as soon as you enter a character (predictive search). The matching names are displayed.
-  *Call*: call the contact.

## 3 Speed dial management

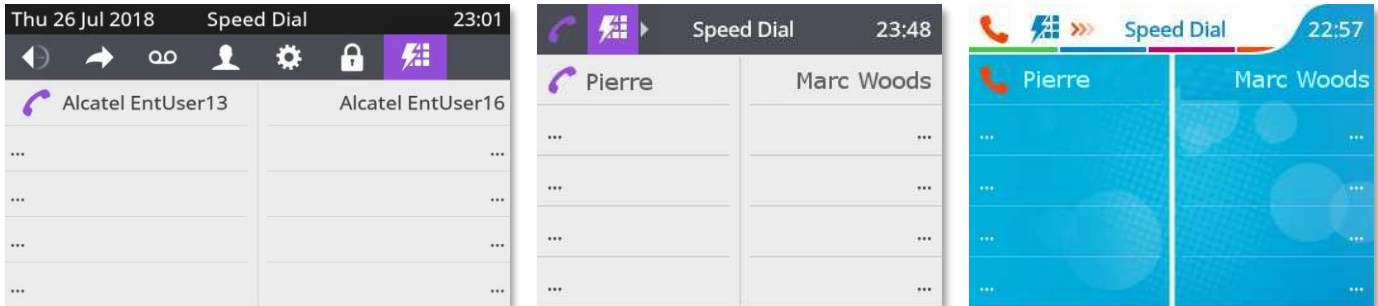
Speed dial lets you manage favorite contacts. Speed dial keys are defined by your administrator. Speed dial keys are programmed from the Web Base Management or via the configuration file. This feature depends on the system configuration. If necessary, contact your administrator.



### 3.1 Make call using speed dial

-  Select the speed dial icon from the phone menu (see the navigation section of your phone model).
- Select the contact to call.
- The call in progress icon is displayed near the contact: .

### 3.2 Presence



The LED lightbulbs in the softkeys of your phone allow you to see the availability of your contact in the speed dial feature (Busy Lamp Field). This depends on the configuration of your system and whether your phone is equipped with LED softkeys.

 When your contact is busy, the 'call in progress' icon is displayed near the contact and the LED softkey remains lit.

# 4 Using your telephone

## 4.1 Information about the phone

Display all information about the phone: name, number, number of missed calls, number of new messages, forwarding status.



- Use one of the following:
  -  Select the information icon from the phone menu (see the navigation section of your phone model).
  - 8078s/8068s /8058s Cloud Edition DeskPhone:  .  
8018/8008/8008G Cloud Edition: **123<>abc** (long press).
- Scroll the page when information need more than one page to be displayed.

## 4.2 Manage the call log











The call log can be consulted and managed when the phone is in the idle state. The main part of the screen is used to display the call log.













-  Select the history icon from the phone menu (see the navigation section of your phone model).
- Open the contact card by selecting the avatar (left side): 

All call logs associated with the selected contact are displayed with an icon showing the type of call.





		Answered incoming calls.
		Unanswered incoming calls.
		Unanswered incoming call that has been acknowledged.
		Answered outgoing calls.
		Unanswered outgoing calls.

Actions are available from the call log.

		Navigate between different pages.
		Go back to the Homepage.
		Press the call key to call back the selected contact.
		Delete the selected entry. Note that no confirmation is requested.
		Delete the entire log associated with the selected contact. Note that no confirmation is requested.

Using the up and down navigation key to scroll through the log.

 **Call your contact back by selecting the call log key (right side)**







		This icon means the call was answered or acknowledged.
		This icon means the call was not answered (missed call). You can acknowledge a missed call by opening the associated contact card or by calling your contact back.



**To display additional pages of the call log**

Depending on your phone, scroll the page by pressing the up or down navigation keys or by sliding the finger up or down on the screen.

## To manage the call log

Depending on your phone, select the following key:





-  Press the menu key at the right top of the screen (8078s CE).
-  Press ok key to open menu.
-  *Delete*  
Press the delete key to delete specific logs >> all call logs are displayed on the screen.  
 Press the 'delete' key.
-  *Delete all*  
Press the key associated with the 'delete all' icon to delete all call logs. Please note that no confirmation is required before deletion.
-  *Missed*  
Press this key to display missed calls only.
-  *Ack all*  
Press this key to acknowledge all missed calls.

 /  From the page containing information about the phone, you can open missed calls by selecting the number of missed calls.

If you are using multiple SIP accounts on your phone, the concerned SIP account is displayed for each entry of the call log.

## 4.3 Calling by number

You can unhook the handset or the headset to make a call with the handset or the headset otherwise you make a call in hands-free mode.

-  Dial the number.
- Use one of the following:
  -  Press the OK key to start the call. Make the call with the headset if connected, or in hands-free mode.
  -  Press the call key. Make the call with the headset if connected, or in hands-free mode.
  -  or  Press the call icon key. This icon is only displayed when the number is recognized.

If your headset has no Off-hook/On-hook key, use the phone keys and switch on the audio on the headset ().

To make an external call, dial the outside line access code before dialing your contact number.





The call will start after a timeout of approx. 10 seconds if there is no action taken after dialling.

If you are using multiple SIP accounts on your phone, you can choose which account to use to make the call.

## 4.4 Making a peer to peer SIP call

Your phone is compatible with the peer to peer SIP call. It is able to call phones connected to the same local network. You can call your contact by entering the IP address of your contact's deskphone.

Make the call with the headset if connected, or in hands-free mode.

-  Enter the IP address of your contact's deskphone (IPv4). The format of the entered IP address must be x.x.x.x or x\*x\*x\*x where x is a decimal value between 0 and 255.
- Use one of the following:
  -  Press the OK key to start the call.
  -  Press the call key.
  -  or  Press the call icon key.





This feature is useful when you have no connection to a communication server (no registration, network problems, etc.). Not all the features are available should this occur and the phone's status should be displayed on the screen. This feature can be deactivated by your administrator.

## 4.5 Calling by name

You can call a contact by his/her name using the search feature in the company directory. This feature depends on the system configuration. If necessary, contact your administrator.

You can unhook the handset or the headset to make a call with the handset or the headset otherwise you make a call in hands-free mode.

Use the alpha-numeric keyboard key to switch between the numeric and alphabetic keyboard.

-  Enter the first letters of your contact's name.
- All matching names are displayed on the screen (if necessary scroll the pages to display additional matching names).
-  or  Call the contact by pressing the call icon key >> the call is started.
-  You can also call your contact from the contact card (*Call*).



If you are using multiple SIP accounts on your phone, you can choose which account to use to make the call.

## 4.6 Call from call log

You can call back a contact from the call log.

You can unhook the handset or the headset to make a call with the handset or the headset otherwise you make a call in hands-free mode.





When on the Homepage.

-  Select the history icon from the phone menu (see the navigation section of your phone model).
  - Find the contact to call by scrolling the list.
  -  Press the relevant callback key in the Call Log (right side) **>>** the call is started.
-  You can also call your contact from the contact card (*Call*).

If you are using multiple SIP accounts on your phone, the call back is made with the SIP account displayed into the call log.

## 4.7 Calling using your personal directory



You can unhook the handset or the headset to make a call with the handset or the headset otherwise you make a call in hands-free mode.

-  Select the local directory icon from the phone menu (see the navigation section of your phone model).
  - Find the contact to call by scrolling the list.
  -  or  Call the contact by pressing the call icon key **>>** the call is started.  
If there are several numbers for the same contact, select the desired number.
-  You can also call your contact from the contact card (*Call*).

If you are using multiple SIP accounts on your phone, you can choose which account to use to make the call.

## 4.8 Calling using speed dial key













You can unhook the handset or the headset to make a call with the handset or the headset otherwise you make a call in hands-free mode.

-  Select the speed dial icon from the phone menu (see the navigation section of your phone model).
- Select the contact to call.
- The call in progress icon is displayed near the contact: .

If you are using multiple SIP accounts on your phone, you can choose which account to use to make the call.

## 4.9 Receiving a call

When receiving a call, you can:

- Lift the handset to take the call.
- Use the headset to take the call. If your headset has no Off-hook/On-hook key, use the phone keys and switch on the audio on the headset ().
-  Press the loudspeaker/hands-free key to take the call in hands-free mode.
-  or  /  Press the 'take the call' or blinking 'line key' key to take the call with the headset, if connected, or in hands-free mode.
-  *Take call* or  **>>** Take the call with the headset if connected, or in hands-free mode.
-  *Reject call* **>>** Reject the call. The incoming call is ended.
-  *Silent* **>>** Mute the ringer (the call is still incoming but the phone no longer rings).
-  *Deflect* **>>** Deflect the call to another contact:
  - Use one of the following:
    - Using the up and down navigator (if necessary), find the contact to call.
    - Enter the number or name of the contact to whom the call will be deflected.
  -  Deflect the call to the selected contact.
-  *Deflect VM* **>>** Deflect the call to your voicemail.

If you are using multiple SIP accounts on your phone, the SIP account that receives the call is displayed on the phone.

## 4.10 Switching between audio modes

During the conversation, you can switch between different audio modes (handset, hands-free or headset, if connected) by pressing the loudspeaker/hands-free key until the desired audio mode is displayed: . This feature depends on connected devices. The key is lit when the loudspeaker or hands-free mode is selected.

You are in conversation with the handset, you can switch between following audio modes by short pressing on the loudspeaker/hands-free key:





You are in conversation with the headset (headset or headset+loudspeaker), you can switch between following audio modes by short pressing on the loudspeaker/hands-free key:



You can switch to loudspeaker (group listening mode with handset) when in conversation by pressing and holding the loudspeaker/hands-free key:











For each audio mode, during the conversation, you can adjust the volume by pressing the volume keys. The number of levels depends on the audio mode (8 for handset and headset 10 for hands-free and loudspeaker). The selected volume, for each audio mode, will be saved for future conversations.

- During a conversation.
-   Adjust volume by pressing the volume keys.

## 4.11 Activating the loudspeaker during a conversation (handset lifted)

Activate or deactivate the loudspeaker when you are in conversation using the handset or the headset.

-  Activate loudspeaker (long press) >>  >> The key lights up (.
-   Adjust volume by pressing the volume keys (number of levels: 10).
-  Deactivate loudspeaker (long press) >>  >> The key is no longer lit (.

Press and release the loudspeaker key to switch to hands-free mode (light steady).

## 4.12 Redialing

-  >> Last number redial.

For the phones 8018/8008G/8008 Cloud Edition DeskPhone, the redial key is associated with the Off-hook key when the phone is in idle state: .





## 4.13 Sending DTMF signals

During a conversation you sometimes have to send DTMF signals, such as with a voice server, an automated attendant or a remotely consulted answering machine.

-  Enter DTMF code.

## 4.14 Mute, so that your contact cannot hear you

You can hear your contact but he/she cannot hear you:





- During a conversation.
-  Disable microphone >>  the mute key blinks.
-  Resume the conversation >>  the mute key no longer blinks.

## 4.15 Interphony (Auto answer)

In the interphony mode, calls are automatically answered.





Interphony (auto answer) is only possible via the configuration file. Contact your administrator if necessary.

## 4.16 Lock / unlock your telephone

-  Select the lock icon from the phone menu (see the navigation section of your phone model).
-  *lock*
-  /  Validate your choice >> Your phone is locked. A lock page is displayed.

You can only call emergency numbers, such as 'Operator' or 'Guard', once the phone is locked (max 3 numbers, configured by the administrator).

When your phone is locked:

-  Unlocking your phone. Your password is required to unlock the phone.
-  Access to the list of emergency numbers
  -  Call the emergency number.
  -  Go back to the lock page.

## 4.17 Making a second call during a conversation

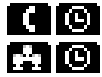
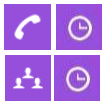

During conversation, you can navigate in the title bar to consult the call log, local directory, contact card or to make a new call for example. The conversation key will be blinking ( ). Select the flashing conversation key to go back to the conversation page.

During a conversation.



- *New call* › the first call is on hold.
- Use one of the following:
  - Call your contact using the dial by name or the dial a number feature (switch to the alphabetical keyboard if you don't have the optional keyboard).



Press the call icon key.



- Select the 'Redial' function.

- / Open the call log or your local directory by using the right navigation key.



Press the call icon key.

- Select a speed dial key.

For the phones 8018/8008G/8008 Cloud Edition DeskPhone, the redial key is associated with the Off-hook key when the phone is in idle state: .

## 4.18 Answering a second call during a conversation

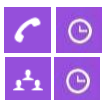

During conversation, you can navigate in the title bar to consult the call log, local directory, contact card or to make a new call for example. The conversation key will be blinking ( ). Select the flashing conversation key to go back to the conversation page.

During a conversation, another person is trying to call you. You are alerted with 3 beeps. The identity of the caller is displayed as long as the call is presented on your phone.



- Use one of the following:
  - *Take call* or ›› Press the 'OK' key or the 'take the call' key
  - *Reject call* ›› Reject the second call.
  - *Silent* ›› Mute the ringer (the call is still incoming but the phone no longer rings).
  - *Deflect* ›› Deflect the second call to another contact:
    - Select a contact in the list or enter the number or the name of the contact you wish to deflect the call to
    - Deflect the call to the selected contact.
  - *Deflect VM* ›› Deflect the second call to your voicemail.

› the first call is on hold.

As long as the call is presented, you can also choose to deflect the call.



## 4.19 To cancel your second call and recover the first

You are in conversation with the second contact and the first one is on hold.



-  You or the second contact hangs up.
-  Press the key associated with: *Retrieve*  
 >> You are on the line with your first contact.

## 4.20 Placing a call on hold (hold)

During a conversation, you wish to place the call on hold and recover it later, on the same telephone.



- During a conversation.
-  Press the key associated with: *Put on hold*  
 >> Your call is placed on hold (.

Recover the call on hold.

- Use one of the following:
  -  Press the blinking line key.
  -  Select the blinking 'call on hold' icon from the top bar (left side).
  -  Press the key associated with: *Retrieve*

## 4.21 Switching between calls (Broker call)

During a conversation, a second call is on hold.

- Use one of the following:
  -  Press the blinking line key.  
 >> You can talk to the second caller and the first one is on hold.
  -  Select the blinking 'call on hold' icon from the top bar (left side).
  -  Press the key associated with: *Retrieve*  
 >> You can talk to the first caller and the second one is on hold.

## 4.22 Transferring a call

This feature can be deactivated by your administrator.

### 4.22.1 To transfer your call to another number

During a conversation.

-  Press the key associated with: *Transfer to*  
 >> the first call is on hold.
- Call the recipient of the transfer using the dial a number or dial by name feature or the call log or local directory.  
 >> the transfer is done as soon as the call is started.

Transfer between two outside calls is not generally possible (depends on country concerned and system configuration).

### 4.22.2 To transfer a call to another contact on hold

During a conversation.

-  Press the key associated with: *Transfer*  
 >> the two callers are connected.



## 4.23 Three-way conference with internal and/or external contacts (conference)

During a conversation, a second call is on hold.

-  *Conference*  
 >> you are in conference mode.

### 4.23.1 End the conference with all participants

You are in conference mode.

- Use one of the following:
  -  Press the on-hook key.
  -  Press the key associated with: *End conf*  
 >> the conference is ended.

### 4.23.2 After the conference, to leave your two contacts talking together

You are in conference mode.



-  *Transfer*  
 >> the two participants remain on the call together.



## 4.24 Five-ways conference with internal contacts - talk simultaneously to more than 2 contacts

This feature depends on the system configuration. If necessary, contact your administrator.





You are in a conference call with 2 contacts. To add another participant to the conference:

-  *Add*
- Dial the number of your contact (dial, directories, last numbers dialed...).
- Your contact answers.
- *Insert* >> you are on the line with the additional contact.
-  The list of participants is displayed.

The number of participants depends on the system configuration. When the maximum of participants is reached, you can no more make a new call to add a new participant.





## 4.25 Hide your phone number

you can choose to hide your identity when calling.

-  Select the settings icon from the phone menu (see the navigation section of your phone model).
- Press the keys associated with: *Phone*
- Select the option: *Anonymous*  
>> your identity will be hidden.
-  or : Validate your choice.
- 

## 4.26 Do not disturb













You can make your terminal temporarily unavailable for all calls.

-  Select the settings icon from the phone menu (see the navigation section of your phone model).
- *Phone*
- Set the option: *DND*
-  or : Validate your choice.
- 

To deactivate the Do not disturb feature, follow the same procedure.

## 4.27 Forwarding to a number or voicemail





When you are absent or already in communication (all lines are busy), all your calls are forwarded to the defined number.

- Use one of the following:
  -  Select the forwarding icon from the phone menu (see the navigation section of your phone model).
  -   Select the forward icon from the information tab.
- Pressing the associated key, select from:
  -  *Deactivate*  
When selecting this option, no forward is activated.
  -  *Immediate*  
All your calls are immediately forwarded to another set or voicemail.
  -  *No Reply*  
All your calls are forwarded to another set or voicemail when you cannot answer.
  -  *Busy*  
All your calls are forwarded to another set or voicemail when you are already on the line.
  -  *Busy/No Reply*  
All your calls are forwarded to another set or voicemail when you cannot answer or when you are already on the line.
- use one of the following:
  -  *Voicemail*: Forward your calls to voicemail (if your voicemail is available).
  -  *User*: Forward your calls to another set.
  -  Select the forwarding destination by dialing directly the number or by searching by name.  
You can also select the user by opening the contact card and press the key: *Forward*
- 

The information page indicates the forward status of your phone (). Immediate forwarding information is displayed at the top of the screen.

The forwarding destination is saved. Next time you use this feature, you can directly activate the last forward by pressing the bullet point for the type of forward (left side): 

## 4.28 Cancelling all forwards

- Use one of the following:
  -  Select the forwarding icon from the phone menu (see the navigation section of your phone model).
  -   Select the forward icon from the information tab.
- *Deactivate*
- 



You can also programme another type of forward to cancel the current forward.



## 4.29 Listen to your voicemail



This feature depends on the system configuration. If necessary, contact your administrator.

The message key flashes when you have received a new voicemail or if you have missed calls.

- Use one of the following:
  -  Press the messaging key.  
Follow the instructions from the voicemail server.
  -  Select the voicemail icon from the phone menu (see the navigation section of your phone model).  
Press the voicemail key: *Voicemail*.  
Follow the instructions from the voicemail server.

## 4.30 Defining an “hotline” number

If configured, the “hotline” number is dialed immediately or after a time delay when you take the line by picking up the handset, by pressing the hands-free button or pressing the call button of the headset. To configure the “hotline” number:

-  Select the settings icon from the phone menu (see the navigation section of your phone model).
- *Phone* > *Hotline*
  - Activate or deactivate the feature.
  - *Delay*: time delay in seconds before the “hotline” number is dialed, if no action is performed during this time (0 – 180s). The “hotline” number is immediately dialed if the delay time is set to 0s.
  - *Number*: enter the number of the “hotline”.
-  To end the settings.

This feature can be configured via the 'Web-Base Management'.

## 5 Make more with your deskphone

Your deskphone is designed to evolve with its environment. It can do more than just establishing a communication between people or keeping in touch with your contacts, your enterprise.

This chapter describes some use-cases with your phone.

### 5.1 Easy Deployment Server (EDS)

Your phone is compatible with the Alcatel-Lucent Enterprise Easy Deployment Server (EDS).

EDS is an easy way to install and configure your DeskPhone: start your deskphone, the EDS procedure is launched. After reboot, your phone is ready to be use.

EDS provides pre-provisioning service and redirection service to download configuration file and reach the final communication server.

- Pre-Provisioning: provide a 'pre-configuration' of the phone before getting the final configuration file in the communication server.
- Redirection: provide the final URL needed for downloading the final configuration file.

The EDS URL is flashed into the ALE DeskPhone during the manufacturing.

Provisioning Server URL is retrieved by the phone after a request to the EDS in two ways:

- MAC based method: MAC address has to be set in EDS configuration. No action needed at the phone level, but costly operations at the infrastructure level.
- Activation code method: the end user has to enter an activation code to identify the device to the EDS server.

EDS is activated by default on your phone.

#### 5.1.1 Installing your phone via EDS

When you unpack your phone, it is ready to be installing via EDS. Your administrator has configured the EDS server for your phone. Depending on the EDS configuration, an activation code could be requested. This code has to be given by your administrator.

- Connect your deskphone to the network (and plug in the power jack if you are using an external power adapter).
- Depending on the configuration of the EDS, an activation code could be requested:
  - Enter the activation code. The number of wrong entered code is limited.
  - Validate.
- After reboot, your phone is ready to be used.

#### 5.1.2 Update your phone configuration via EDS

- Connect your deskphone to the network (and plug in the power jack if you are using an external power adapter).
- When your phone is started:
  -  Using the left-right navigator keys, select the settings menu.
  - *Phone*
  - *EDS*
  - *Force update*  
Select this option to start the installation and configuration of your phone via EDS.
- Depending on the configuration of the EDS, an activation code could be requested:
  - Enter the activation code. The number of wrong entered code is limited.
  - Validate.
- After reboot, your phone is ready to be used.

### 5.1.3 Error messages

If an error occurs, a pop-up is displayed on your deskphone:

- *EDS is not reachable*: the phone cannot reach the EDS server.
- *Invalid provisioning file*: the download provisioning file is invalid.
- *Error code, x attempt left before phone is locked*: wrong activation code entered. The number of attempts still possible is displayed.
- *Phone is locked due to max login reached or in black list*: wrong activation code entered more than 10 times, or your phone is in a EDS blacklist.
- *Input code is rejected cause of max allowed device reached*: an activation code can be used by many phones. A maximum of deskphones associated with an activation code is defined on EDS. This error is displayed when the maximum of uses is reached.

## 5.2 Configure your phone for teleworking

Your IP phone is compatible with teleworking (VPN) via a secure connection (encrypted). Your phone is supported IKEv1 and IKEv2 protocol to send data securely. In this mode, all features available at your office will be ready for use remotely.

If the telephone system of your enterprise is configured to accept remote workers (system and infrastructure), you have to configure your deskphone to be ready for teleworking.

The configuration of the phone depends on the infrastructure of your telephony network.

For information, please consult the following guide:

- “IPsec VPN Deployment Guide for Remote Workers for DeskPhones and Premium DeskPhones s Serie “ 8AL90345ENAA (<https://businessportal2.alcatel-lucent.com/8AL90345ENAA>)

There are two ways to configure your phone for teleworking:

- By using the Easy Deployment Server (EDS).
- By entering manually configuration information.

In this section, we describe the complete configuration of your phone for teleworking.

Your installer has to give you all information to configure your deskphone.

You have to:

- Enable VPN.
- Enter the remote VPN server information.
- Enter the VPN DM URL.
- Enter authentication.
- Setup the VPN start preferences.

### 5.2.1 PIN code

the PIN code is composed of 4 digits. You can access the VPN configuration by entering the PIN code or the administrator password if defined by the system. Depending on the VPN configuration, the PIN code is requested when you boot your deskphone. We recommend you enable this option for security reasons and if you need your phone in remote and in business place (see Reconnect your deskphone in your business place).

If the PIN code is incorrect 5 times in succession, the PIN code and VPN parameters will be erased.

If no administrator password is defined by the system, the PIN code is required to access VPN configuration.

## 5.2.2 Access to the VPN configuration

There are two ways to access VPN configuration:

- During the boot:
  - Connect your deskphone to the network (and plug in the power jack if you are using an external power adapter).
  - When the deskphone displays the 'Step 2' during the boot, repeatedly press the '\*' and '#' keys in succession until a menu is displayed.
  - Depending on the configuration, enter the PIN code or the administrator password.
  - *VPN*
- From the settings of the phone:
  -  Using the left-right navigator keys, select the settings menu.
  - *Phone*
  - *VPN*
  - Depending on the configuration, enter the PIN code or the administrator password.
- From the Web-Base Management

## 5.2.3 First connection as teleworking







When you connect your deskphone for the first time remotely, you are prompted to set a PIN code. The PIN code is requested when you enter in the VPN configuration (submenus) or when you boot your deskphone (depending on the VPN configuration).





The PIN code is retained during the session so that you can access the VPN configuration without having to re-enter your PIN code until you exit the VPN configuration.

Before configuring your phone for teleworking, check if you have all the information from your administrator.

If your set is not provided with a magnetic keyboard, use the alpha-numeric keyboard to enter letters.

To configure your deskphone:

- Access to the VPN configuration (see: 5.2.2).
- *VPN Config*
  - *Enable VPN*: you have to activate this option to use your deskphone for teleworking.
  - *Server*: enter the address of the VPN server.
  - *PSK*: enter the pre-shared key to establish a secure connection with the VPN server. The PSK can be unique for all remote workers on a same installation or can be specific to each remote worker. In the first case, the VPN authentication has to be enabled.
  - *IKE vers*: enter the IKV version (IKEv1/IKEv2).
  - *IKEv1 aggressive*: select this option if IKEv1 is used.
  -  or : validate your choice.
- *VPN Auth*
  - *Use Authentication, User, Pass*: activate this option if a logon to the VPN server (username and password) is required. The VPN authentication can be disabled in case a specific PSK is used for each remote worker.
  -  or : validate your choice.
- *VPN Pincod*
  - *Request Pin on Boot*: if this option is activated, the PIN code is required when you boot your deskphone. We recommend you activate this option.
  - *Set new Pincod*: enter the new PIN code.
  -  or : validate your choice.
- *VPN DM URL*:



- Enter the VPN DM URL where the configuration file is stored.
-  or : validate your choice.
- *VPN Default Settings:*
  - Restore default settings.
  -  or : validate your choice.
-  The deskphone restarts.
- Enter the PIN code if you have selected the option (*Request Pin on Boot*).
- Validate.
- Your deskphone is ready for teleworking.

If you leave the PIN code request menu when the phone is starting, the phone will start without VPN activated.

If an error occurs when your phone is running in remote mode, a popup is displayed with an error message. Please note this message to send to your administrator.



### 5.2.4 Change the configuration

You have to change a parameter of the VPN configuration.

- Access to the VPN configuration (see: 5.2.2).
- Select a submenu to change the configuration (*VPN Config, VPN Auth, VPN Pincod, VPN DM URL*).
- Enter your PIN code (if an administrator password is defined by the system, you can use it to access to the VPN configuration by selecting: *Use Password*).
- Validate.
- Change parameters.
-  or : validate your choice.
- The deskphone restarts.
-  The deskphone restarts.
- Enter the PIN code if you have selected the option (*Request Pin on Boot*).
- Validate.
- Your deskphone is ready for teleworking.



If an error occurs when your phone is running in remote mode, a popup is displayed with an error message. Please note this message to send to your administrator.

### 5.2.5 Reset your PIN code

- Access to the VPN configuration (see: 5.2.2).
- *VPN Pincod*
- Enter your PIN code.
- Validate.
- *Set new Pincod:* enter the new PIN Code.
-  or : validate your choice.
-  The deskphone restarts.
- Enter the PIN code if you have selected the option (*Request Pin on Boot*).
- Validate.
- Your deskphone is ready for teleworking.



## 5.2.6 Reconnect your deskphone in your business place

Your phone is already configured for teleworking.

- Connect your deskphone to the network (and plug in the power jack if you are using an external power adapter).
- If the option to enter PIN code when you boot your deskphone is enabled in the VPN configuration (*Request Pin on Boot*):
  - The PIN code is requested.
  -  Select this icon to go back.
  - The phone restarts in normal mode. The VPN is temporary disabled until the next reboot.
- If the option is not enabled:
  - Access to the VPN configuration (see: 5.2.2).
  - *VPN > VPN Config*
  - Enter your PIN code.
  - Validate.
  - *Enable VPN*: disable the teleworker.
  -  The deskphone restarts.
  - Enter the PIN code if you have selected the option (*Request Pin on Boot*).
  - Validate.
  - The phone restarts in normal mode.

## 5.2.7 Reconnect your deskphone in remote place

Your phone is already configured for teleworking but it was connected in your place of business. You need to reconnect it in a remote place.

- Connect your deskphone to the network (and plug in the power jack if you are using an external power adapter).
- If the option to enter PIN code when you boot your deskphone is enabled in the VPN configuration (*Request Pin on Boot*):
  - The PIN code is requested.
  - Enter PIN code.
  - Validate.
  - The phone starts as teleworker.
- If the option is not enabled (*Request Pin on Boot*):
  - Access to the VPN configuration (see: 5.2.2).
  - *VPN Config*
  - Enter your PIN code.
  - Validate.
  - *Enable VPN*: enable the teleworker.
  -  or : validate your choice.
  -  The deskphone restarts.
  - Enter the PIN code if you have selected the option (*Request Pin on Boot*).
  - Validate.
  - The phone starts as teleworker.

If an error occurs when your phone is running in remote mode, a popup is displayed with an error message. Please note this message to send to your administrator.





## 5.3 Desk sharing (Hot desking)

This feature allows you to use any Alcatel-Lucent Cloud Edition deskPhone in your enterprise with your own phone number. When you activate your account onto a deskphone, you retrieve all your phone configuration: local directory, history. After reboot the phone restarts with its initial configuration.

We recommend to have only one phone number activated in the same time to be sure to receive all incoming calls into the same phone.

This feature has to be activated by the administrator of the phone.



### 5.3.1 Login the desk sharing

When you start the desk sharing feature, all user configuration of the phone is cleared.

-  Select the settings icon from the phone menu (see the navigation section of your phone model).
- *Hot desking* › A pop-up is displayed to confirm to clear the current configuration of the phone.
- **Yes:** Confirm
- The phone is unregistered.
- Enter the phone number and password of the SIP account › the deskphone is loading the Sip account configuration. You can use it as your own deskphone.

### 5.3.2 Logout the desk sharing

When you want to leave the office, and retrieve the initial state of the phone, you have to reboot the phone.

-  Select the settings icon from the phone menu (see the navigation section of your phone model).
- *Reboot* › A pop-up is displayed to confirm to clear the current configuration of the phone.
- **Yes:** Confirm
- 

## 5.4 Third-Party Call Control (3PCC)

the availability of this feature depends on your system and its configuration.

Your phone is compatible with 3rd Party Call Control. You can manage calls (basic features) from your computer via a third party application, such as Alcatel-Lucent Rainbow application. This feature depends on the configuration of the system and the third party application you are using.

### 5.4.1 Rainbow application

Your phone is compatible with third-Party Call Control to manage calls (basic features) from your computer via the Alcatel-Lucent Rainbow application:





- Make and answer calls.
- Put on hold/retrieve your contact.
- Transfer a call.
- Consultation and configuration of the mail box (if defined).

# 6 Programming your telephone







## 6.1 Adjusting the audio functions

These features can be configured via the 'Web-Base Management'.





### 6.1.1 Select the melody

-  Select the settings icon from the phone menu (see the navigation section of your phone model).
- *Phone > Ringing*
- The tune must be chosen for external and internal calls: *Ext. Melody/Int. Melody* (optional)
- Select the melody of your choice (16 tunes).
-  or : Validate your choice.
-  To end the settings.



### 6.1.2 Adjusting the ringer volume

-  Select the settings icon from the phone menu (see the navigation section of your phone model).
- *Phone > Ringing > Level*
-   Select the volume you want (9 levels).
-  or  Validate your choice.
-  To end the settings.

### 6.1.3 Configure the ringtone

-  Select the settings icon from the phone menu (see the navigation section of your phone model).
- *Phone > Ringing > Ringing mode*
- Pressing the associated key, select from:
  - *Normal ringing*  
A normal ring signals an incoming call.
  - *Silent mode*  
The phone no longer rings. The LED flashes to signal an incoming call.
  - *Progressive Ringing*  
A progressive ring signals an incoming call.
-  or  Validate your choice.
-  To end the settings.

### 6.1.4 Configuring discreet mode (beep)





-  Select the settings icon from the phone menu (see the navigation section of your phone model).
- *Phone > Ringing > Beep*
- Pressing the associated key, select from:
  - *1 beep before ring*  
A beep followed by the ring signals an incoming call.
  - *3 beep before ring*  
Three beeps followed by the ring signals an incoming call.
  - *Ring without beep*  
A normal ring signals an incoming call.
-  or  Validate your choice.

-  To end the settings.

### 6.1.5 Seat mode





Your deskphone supports the seat mode. The seat mode lets your administrator to switch the ringing onto the loudspeaker, the headset or both. This feature is configurable from the Web Base Management. Contact your administrator for more information.

## 6.2 Adjust ringer volume while a call arrives



- Your telephone rings.
-   Adjusting the ringer volume.
-  or  Validate your choice.
-  To end the settings.

## 6.3 Configuring the welcome page







Define the default page and tabs displayed by on the phone.

-  Select the settings icon from the phone menu (see the navigation section of your phone model).
- *Phone* > *homepage*
  - *Default*: select the default page (*Information, history, Forward, Voicemail, Contacts, Settings, Lock, Speed Dial*).
  - *Hide/display*: Select displayed tabs.
  - *Order*: Set the displayed order of the tabs
    - ∨ : Go down.
    - ∧ : Go up.
-  or  Validate your choice.
-  To end the settings.

## 6.4 Selecting language







-  Select the settings icon from the phone menu (see the navigation section of your phone model).
- *Phone* > *Language*
- Select the language of your choice.
-  Press the OK key to validate your choice.
-  To end the settings.

## 6.5 Adjusting the contrast of the display (8018 CE, 8008g CE, 8008 CE)







-  Select the settings icon from the phone menu (see the navigation section of your phone model).
- *Phone* > *Contrast*
-   Adjust contrast.
-  or  Validate your choice.
-  To end the settings.

## 6.6 Adjusting the brightness of the deskphone (8078s CE, 8068s CE, 8058s CE)





### 6.6.1 Adjust the brightness when the phone is in use

-  Select the settings icon from the phone menu (see the navigation section of your phone model).
- *Phone > Display > Brightness*
-   Increase or decrease the brightness.
-  or  Validate your choice.
-  To end the settings.

### 6.6.2 Adjust the dimmed brightness when the phone is not in use

-  Select the settings icon from the phone menu (see the navigation section of your phone model).
- *Phone > Display > Low brightness*
-   Increase or decrease the brightness.
-  or  Validate your choice.
-  To end the settings.

### 6.6.3 Set the delay before the screensaver starts





-  Select the settings icon from the phone menu (see the navigation section of your phone model).
- *Phone > Display > Screensaver*
- Enable or disable the screensaver.
- Set the time delay (60s – 18000s).
- If the automatic lock on the screensaver is enabled, your phone will lock as soon as the screensaver starts. A lock icon is displayed on the screensaver page.
-  or  Validate your choice.
-  To end the settings.

This feature can be deactivated by your administrator.

### 6.6.4 Auto-adjusting of the brightness



The phone can automatically adjust the display brightness, LED and busy light logo on the back shell (if present) depending on the lighting conditions to improve user experience and achieve power savings (ambient light sensor).

Auto-adjusting of the display brightness:

-  Select the settings icon from the phone menu (see the navigation section of your phone model).
- *Phone > Display*
- *Auto-Brightness*: activate or deactivate the feature.
-  or  Validate your choice.
-  To end the settings.

### 6.6.5 Adjust the LED brightness

-  Select the settings icon from the phone menu (see the navigation section of your phone model).
- *Phone > Display*
- *LED Brightness*: activate or deactivate the feature.

-  or  Validate your choice.
-  To end the settings.

## 6.7 Programmable keys (8018 CE, add-on module)

### 6.7.1 8018 Cloud Edition DeskPhone

Your phone has 4 programmable keys with led and paper label. These keys are used to program a direct call. You can use the paper to describe the key. These keys are configured by the administrator from the Web Base Management or via the configuration file. Led behavior may differ depending on the system configuration.

For more information, contact your installer or administrator.

### 6.7.2 add-on module

These keys are configured by the administrator from the Web Base Management or via the configuration file. led behavior may differ depending on the system configuration.

For more information, contact your installer or administrator.

## 6.8 install a jack accessory (headset, hands-free, loudspeaker)



By default, the audio jack of your telephone can be used to connect a headset, hands-free kit or loudspeaker. A wideband headset can also be installed for optimized sound quality.

When you plug the jack accessory in the jack, a popup asks you for the type of accessory:

- *Headset*
- *Handsfree*
- *Loudspeaker*

A specific icon is displayed in the status bar: .

If necessary, you can also select the accessory type in the audio settings:



-  Select the settings icon from the phone menu (see the navigation section of your phone model).
- *Phone > Audio > Jack*
- Select the type of device plugged into the jack: *Headset / Handsfree / Loudspeaker*
- 

Your phone is equipped with a 3.5 mm, 4 pole jack. If your device is not compatible, you can use a 3 pole to 4 pole jack adapter.

## 6.9 Install a USB accessory (Headset, Handsfree, Loudspeaker)

- Connect the accessory to the USB connector.
- When you plug the accessory in the USB port, the USB accessory is automatically detected. If an another accessory is already connected with the same function (USB and jack), a pop-up will ask you to select your preferred accessory to use for this function.

If necessary, you can also select the accessory type in the audio settings:

-  Select the settings icon from the phone menu (see the navigation section of your phone model).
- *Phone > Audio > USB*
- Select the type of device connected to the USB: *Headset / Handsfree / Loudspeaker*
- 

## 6.10 Install a RJ9 headset (8008g CE, 8008 CE)



You can connect a corded headset to your phone using the RJ9 connector behind the phone. Your headset must be compatible with the connector or an adapter must be used. Some USB or jack headsets can be used with a RJ9 adapter. Consult the list of accessories for compatible headsets: List of accessories.

## 6.11 Manage connected devices

### 6.11.1 List of connected devices

-  Select the settings icon from the phone menu (see the navigation section of your phone model).
- *Phone* > *Audio*
- You can find information about which device is connected to the jack or USB connector.
  - USB: *None / Headset / Handsfree / Loudspeaker*
  - Jack: *None / Headset / Handsfree / Loudspeaker*
  - Bluetooth: *None / Headset / Handsfree / Loudspeaker*

### 6.11.2 Set accessory type for each connector

-  Select the settings icon from the phone menu (see the navigation section of your phone model).
- *Phone* > *Audio*
- Use one of the following:
  - USB:  
Select the type of device connected to the USB: *Headset / Handsfree / Loudspeaker*
  - Jack:  
Select the type of device plugged into the jack: *Headset / Handsfree / Loudspeaker*
  - Bluetooth (compatible Bluetooth® deskphone):  
Select the type of device paired with your phone: *Headset / Handsfree / Loudspeaker*
- 

### 6.11.3 Default device

If you have connected the same type of accessory in the jack and the USB connectors, you can define which device will be used by default.

-  Select the settings icon from the phone menu (see the navigation section of your phone model).
- *Phone* > *Audio*
- *Accessory type*
- Select the default connector (then the accessory) to be used: *None / Jack / USB / Bluetooth* (compatible Bluetooth® deskphone).

## 6.12 Manage Bluetooth® device (8078s CE, 8068s CE)

This feature is only available with compatible Bluetooth® deskphone. Otherwise the corresponding menu is not displayed or is inactive. This feature can be deactivated by your administrator.



### 6.12.1 Installing a Bluetooth® device

Before performing the pairing operation, the device must be in detectable mode. Consult the user documentation of your Bluetooth® device.

-  Using the left-right navigator keys, select the settings menu.
- *Phone* › *Bluetooth®* › *Add device*.  
›› scanning starts.
- Searching for Bluetooth® equipment. Wait for the detected equipment type and address to be displayed.
- Select the relevant device by pressing the associated key.
- Add the device by pressing on the associated key: *Add device*.
- Enter the PIN code of the device if necessary.

### 6.12.2 Remove a Bluetooth® device

You can uninstall a Bluetooth® device such as a handset from your phone.

-  Using the left-right navigator keys, select the settings menu.
- *Phone* › *Bluetooth®* › *My devices*.  
›› the paired devices are displayed.
- Select the device to be removed by pressing the associated key.
-  Press the 'remove' key ›› message acknowledging the equipment has been removed.

### 6.12.3 Consult your paired Bluetooth® devices

-  Using the left-right navigator keys, select the settings menu.
- *Phone* › *Bluetooth®* › *My devices*.  
›› the paired devices are displayed.

### 6.12.4 Consult your Bluetooth® parameters

-  Using the left-right navigator keys, select the settings menu.
- *Phone* › *Bluetooth®* › *BT parameters*.  
›› the Bluetooth® parameters are displayed.



# 7 Contacting your administrator (technical support)

If necessary you may need to contact your administrator.

Before contacting your administrator, make sure you have information such as your phone's codes and software version to hand.

## 7.1 Technical code / Date code

The codes are located under the backshell of the phone. This label is an example and does not represent the one placed on your phone.

- 1 Technical code.
- 2 Date code.

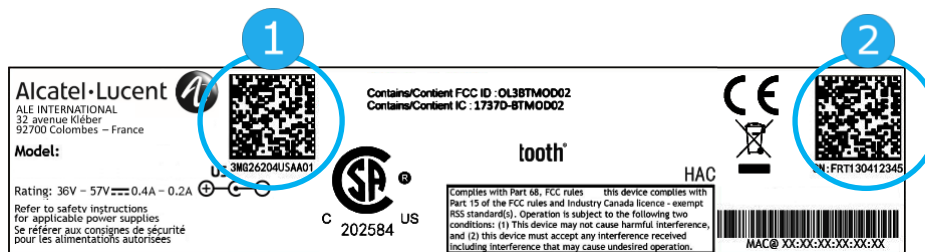

## 7.2 Software version

The software version can be viewed on the phone by following this path:

-  Select the settings icon from the phone menu (see the navigation section of your phone model).
- *Version*

## 7.3 Display network settings

-  Select the settings icon from the phone menu (see the navigation section of your phone model).
- *Network*

## 7.4 Reboot your phone

-  Select the settings icon from the phone menu (see the navigation section of your phone model).
- *Reboot*

## 7.5 Access to administrator configuration

### 7.5.1 Administrator settings menu

-  Select the settings icon from the phone menu (see the navigation section of your phone model).
- *Admin*
- Enter the administrator password.
- This section allows the administrator to set IP parameters, certificates, LDAP servers, DM URL (for configuration files), and SIP Accounts. The administrator can also restore factory settings. The

DM URL is used to automatically download the phone's configuration file, including all parameters, when the phone switches on.

## 7.5.2 Web-Base Management (WBM)

Web-base Management offers to the administrator an easy way to configure the settings of your phone through a web page hosted by your phone.

When phone is connected to the network, your administrator can access to the Web-Base Management via Web browser by entering the IP address of your phone. The administrator password of the phone is requested.

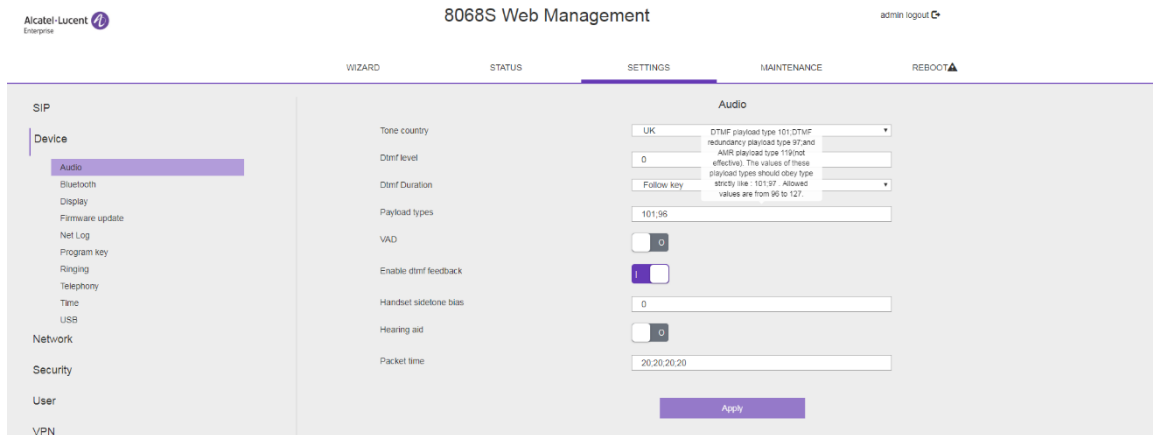

From the Web-Base Management, your administrator can configure audio settings (tone country, DTMF, Hearing aid, ...), Bluetooth settings, screensaver, hotline number, programmable keys, ringing, seat mode (ringing on loudspeaker or on headset or both), telephony settings (dialing rules, voicemail, auto answer, hide identity, transfer, ...). He can manage password, binary update, export/import the configuration of the phone, export/import contact numbers, ...

Consult the Web-Base Management guide for more informations.

## 8 Accessories

The ALE-supported accessories are intended to work smoothly on most/all of our clients (hardphones, softphones). The list of accessories presented in this document is not contractually binding and may be modified without prior warning.

### 8.1 List of accessories

#### 8.1.1 Jack 3.5 mm 4-pole corded headset

- Corded Premium Monaural Wideband Headset 3GV28047BA (Sennheiser SC 232)\*\*  
HD voice - Easy Disconnect - Cables Jack 3,5 mm, 4-pole and 3-pole
- Corded Premium Binaural Wideband Headset 3GV28048BA (Sennheiser SC 262)\*\*  
HD voice - Easy Disconnect - Cables Jack 3,5 mm, 4-pole and 3-pole
- Corded Monaural Wideband Headset 3GV28047AD (Plantronics HW510N)\*  
Quick Disconnect (QD) - Cables Jack 3,5 mm, 4-pole and 3-pole
- Corded Binaural Wideband Headset 3GV28048AD (Plantronics HW520N)\*  
Quick Disconnect (QD) - Cables Jack 3,5 mm, 4-pole and 3-pole
- Corded Monaural 3BN78815AB (Plantronics C215)  
Cables Jack 3,5 mm, 4-pole and 3-pole

\*Compatible with the 8008/8008G Cloud Edition DeskPhone with the following RJ9 adapter:  
QD RJ9 adaptater 3GV28177AA.

\*\*Compatible with the 8008/8008G Cloud Edition DeskPhone with the following RJ9 adapter:  
Sennheiser CSTD 01.



#### 8.1.2 USB headset

- USB Binaural Headset 3GV28057AB (Plantronics C325-1)

#### 8.1.3 Adapter

- QD RJ9 adapter 3GV28177AA (box of 10 - Plantronics).
- 80XX JACK 4-3 POLE CABLE (box of 10) 3MG08018AA.
- 80x8S SATA-RJ11 CABLE (box of 10) 3MG08019AA.
- USB C to USB-A CABLE (box of 10) 3MG08020AA.

#### 8.1.4 Conference module

- 8105s EGO.
- 8135s IP Conference Phone.
- Alcatel-Lucent 8125 Audiooffice usb.
- Alcatel-Lucent 8115 Audiooffice usb.

#### 8.1.5 EHS interface

- External ringing interface module 3GV28050AA (MWS)
- USB external ringing interface module 3GV28184AA (USB Interface module 2 relays)

#### 8.1.6 USB Dongle

- Dongle USB OmniAccess Stellar BLE (box of 10) OAL\_PT\_USB\_10.
- Wifi dongle Edimax AC 1200 Dual Band WiFi USB 2.0 Adpater EW-7822ULC.

### 8.1.7 Other accessories (headsets)

Please consult the following sites of providers for compatible headsets:

- <https://www.plantronics.com/us/en/solutions/alcatel-lucent>
- <https://en-de.sennheiser.com/alcatel-lucent-headsets-unified-communications>
- <https://www.emea.jabra.com/business/for-your-platform/alcatel-lucent>



## 8.2 8105s EGO

	8078s CE	8068s CE	8058s CE	8018 CE	8008/8008G CE
The accessory is supported by the following sets	●	●	●	●	

The Alcatel-Lucent 8105s EGO is a compact and portable conference module. It provides OmniSound® audio technology for very high-quality HD audio conversations. In addition, the 8105s EGO comes with a 1000m Ah Li-ion battery for up to 12 hours of meetings and calls. The 8105s EGO can be connected to your deskphone, mobile phone, tablet and computer.

This section describes how to use the conference module with your deskphone. To use the 8105s EGO with your computer, mobile phone, or tablet, or for more information about the device, see the complete user manual of the device (8AL90358xxAA).

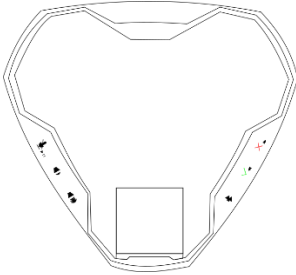
### 8.2.1 Box content

- 8105s EGO 
- 8105s ego case 
- Micro-USB cable 

### 8.2.2 Description

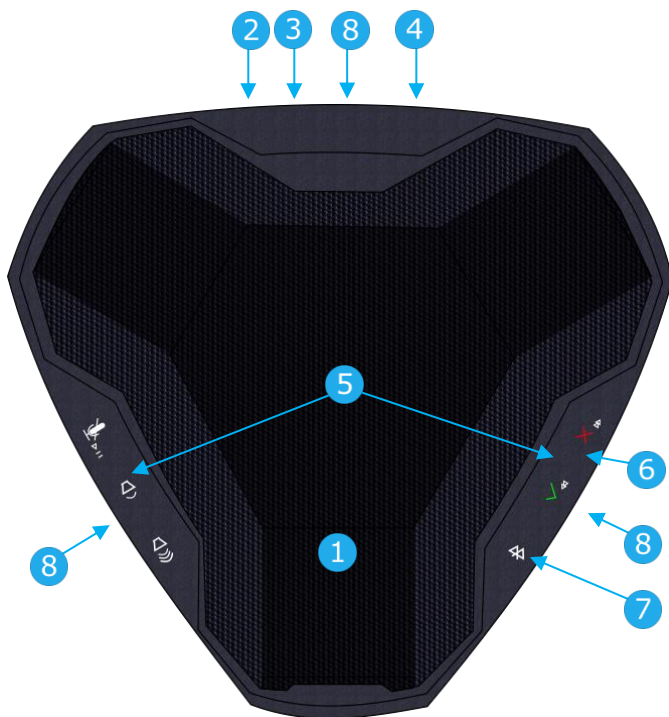













- 1** Color display.
- 2** Off/on button.
  - Push the button to start.
  - Hold down the button for five seconds to manually switch off.
  - The 8105s EGO switches off automatically after 30 minutes.
- 3** USB connector (micro type B).
- 4** 3.5 mm, 4 pole jack (TRRS standards: CTIA)
- 5** Audio control buttons
  - Activating and disactivating the mute.
  - Turn up the volume.
  - Turn down the volume.
  - Start/pause music.
  - Previous music.
  - Next music.
- 6** Call control buttons
  - End the call.
  - Answer the call.
- 7** Button for pairing Bluetooth®.
- 8** LED (all side)

### 8.2.3 LED description

- Steady yellow: The device is switched on.
- Blue steady: Connected through Bluetooth®.
- Green steady: Microphone is enabled/call in progress (Bluetooth®).
- Flashing green: Incoming call (Bluetooth®).
- Flashing blue: Pairing or connecting in progress (Bluetooth®).
- Red steady: Microphone switched off during calls (mute).
- Flashing red: Low battery.
- Flashing slowly: the call is placed on hold (Bluetooth®).

### 8.2.4 Icons displayed on the screen

The icons are normally displayed for a couple of seconds on connection. The same symbol is displayed in red when the connection is broken.

	USB device connected.		Incoming call or call in progress via Bluetooth®.
	Incoming call or call in progress via USB.		Music mode via Bluetooth®.
	Music mode via USB.		Headset connected.
	Visible for pairing via Bluetooth®.		Volume adjustment (number of bars indicates the volume selected).
	Reconnecting to Bluetooth® device.		Microphone switched off (mute).
	Bluetooth® device connected.		Battery status.

### 8.2.5 Battery charge



Displayed automatically when there is 1 hour remaining and then every 5 minutes. The number of bars in the battery icon indicates the charging status. The battery needs charging when the icon turns red. Charging the battery with a USB cable.

### 8.2.6 Turning off and on

The 8105s EGO starts automatically when it is connected with the provided USB cable to the deskphone or powered-up computer.











- Push the button to start manually the device.
- Hold down the button for five seconds to manually switch off.

### 8.2.7 Connect the device to the deskphone using the USB cable

- Connect the device to the USB type A connector of the deskphone using the provided USB cable. The 8105s EGO automatically starts. The following icon is displayed on the screen of the device:  .
- The 8105s EGO is detected as a hands-free device. Select “Konftel Ego” on the pop-up displayed on your deskphone.
- The device is ready for use

## 8.2.8 Connect the device to the deskphone using Bluetooth® (compatible Bluetooth® deskphone)







-  Switch on the 8105s EGO.
  - Put the device in detectable mode: hold down for two seconds the Bluetooth® button on the 8105s EGO: . The following icon is displayed on the screen of the device: .
  - From your deskphone, pairing the 8105s EGO:
    -  Using the left-right navigator keys, select the settings menu.
    - *Phone > Bluetooth® > Add device*
- » searching for Bluetooth® equipment. Wait for the detected equipment type and address to be displayed
- Select the relevant equipment: “Konftel Ego”
  - *Add*
- The 8105s EGO is successfully paired. The following icon is displayed a couple of seconds on the 8105s EGO screen: . It is detected as a Bluetooth® headset. The following icons are displayed on the status bar of your deskphone: , .

: this icon is only available on the 8078s Premium DeskPhone.

To remove the device, follow instructions described in the section: “Removing a Bluetooth® accessory (headset, handset, etc.)”.

## 8.2.9 Using the 8105s EGO

The 8105s EGO is used as an external hands-free device.

- When you receive a call, the device is ringing and an icon is displayed on the screen:  / . The leds are flashing green.
-  Answer the call.
-  Activate/deactivate the mute feature during a conversation. The mute icon is displayed on the 8105s EGO if activated: .
- Use the volume buttons of the deskphone or 8105s EGO to up or down the volume.
-  End the call. You can end the call from the deskphone.

You can resume the call with the handset at any time by unhooking it or by switching between audio mode ().



### 8.3 8115/8125 Audiooffice



	8078s CE	8068s CE	8058s CE	8018 CE	8008/8008G CE
The accessory is supported by the following sets	Jack	Jack	Jack	USB	

This section describes how to use the conference module 8115/8125 Audiooffice with your deskphone. For more information about 8115/8125 Audiooffice see the user manual of the device.

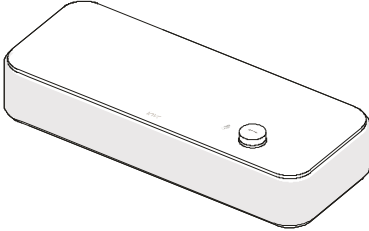
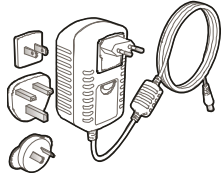
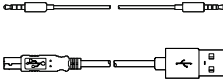
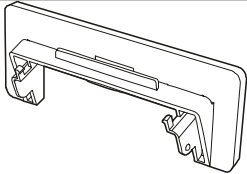
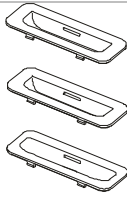
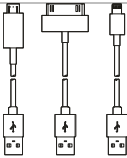
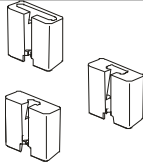
#### 8.3.1 Box content

		8115 Audiooffice	8125 Audiooffice
Alcatel-Lucent 8115 Audiooffice base		●	
Alcatel-Lucent 8125 Audiooffice base			●
AC adapter		●	●
Jack 3.5 mm cable USB type A - type B cable		●	●
Tablet holder			●
Lightening, 30 pin and micro-USB adapters			●
Lightening, 30 pin and micro-USB cables			●
Lightening, 30 pin and micro-USB cable adapters			●

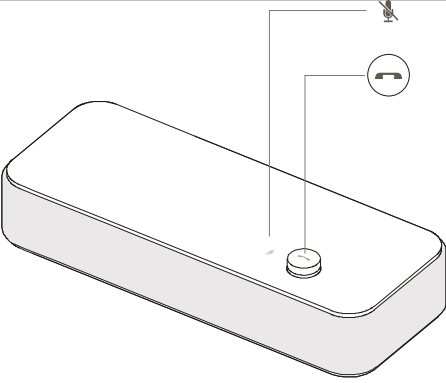
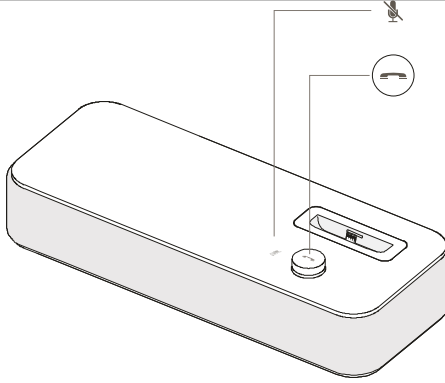
### 8.3.2 Description

8115 Audiooffice		8125 Audiooffice	
			
	Mute	Mute	
	Adjust volume. Receive and End a call.	Adjust volume. Receive and End a call. Bluetooth pairing.	

### 8.3.3 Set-up

Once installed, to benefit from the best sound quality avoid placing any objects (walls or cumbersome objects) within a range of 20cm.

1. Plug the mains power adapter into the back of the base and into a wall mount socket.

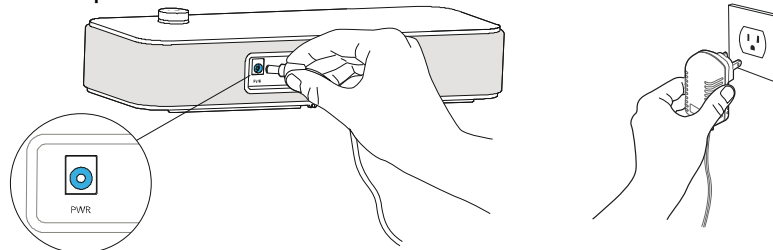

2. Press the On / Off button at the back of the base.

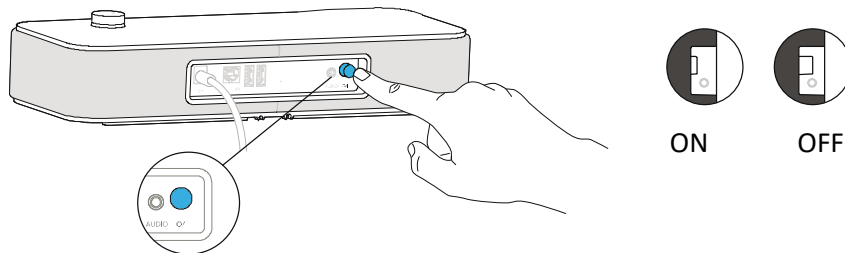

### 8.3.4 Connect your devices

#### 8078s/8068s/8058s Cloud Edition Deskphone

The conference module is equipped with a 3 pole jack. You have to use a 3 pole jack to 4 pole jack adapter to connect the conference module to your deskphone. Use the provided jack cable connected to the conference module and a 3 pole jack to 4 pole jack adapter connected to your deskphone.

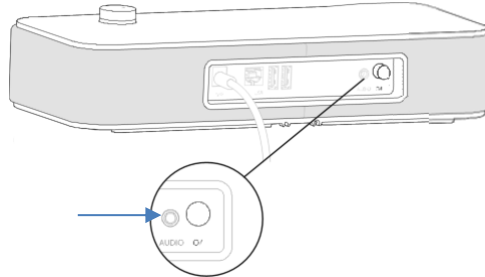

#### 8018 Cloud Edition DeskPhone

The USB slave port is to connect your deskphone to have the sound on the 8115/8125.

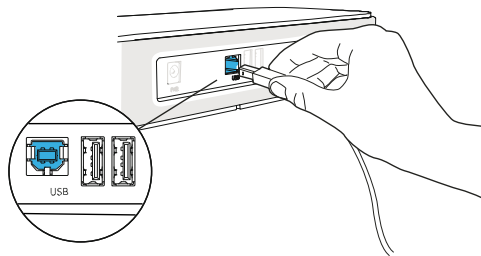

#### Other Devices

The 8115/8125 Audiooffice can be used to connect other device, like mobile phone (via Bluetooth, USB or Jack) or computer (Bluetooth, USB or Jack).

### 8.3.5 Bluetooth (8125 Audiooffice)

The voice messages are in English until a first device is paired, the unit will then adopt the language of the Bluetooth device paired.

Long push the volume button until you hear a sound signal. A 'Pairing mode: waiting for connection' message allows you to pair your Alcatel-Lucent 8125 Audiooffice in your device Bluetooth menu. A final sound confirms the pairing.

#### Disconnect a paired device

Long push the volume button until hearing a double-sound signal. The last connected device is then disconnected and auto-connection is stopped. A 'Disconnecting' message and a sound signal confirm the disconnection.

#### Unpair all the connected devices

Long push the volume button until hearing a three-sound signal. A 'Clearing all subscriptions' message confirms it.

### 8.3.6 Use your device

Use the 8115/8125 Audiooffice as a conference module.

#### **Placing or receiving an Alcatel-Lucent Deskphone call in jack mode**

Upon jack connection to the Alcatel-Lucent Deskphone, user needs to configure the jack interface to 'External Handsfree' in order to use it for conference.

The jack connected, dial from your Alcatel-Lucent Deskphone and press the Alcatel-Lucent 8125 Audiooffice volume button to use it as a conference device.

To end the call, hang up the call from the phone.

Muting a call can be done with the Audiooffice Mute button or thru the Alcatel-Lucent Deskphone Mute key.

#### **Adjusting the volume**

Turn the volume button to regulate the volume coming from the speakers.

#### **Activating and disactivating the mute**

Tap the Mute icon from your Alcatel-Lucent deskphone or directly from the Alcatel-Lucent 8125 Audiooffice icon.

#### **Activating and disactivating the speakers**

To accept a call in speaker mode or to switch to speaker mode during a call, press the volume button on the base.

### 8.3.7 Use the 8125 Audiooffice with your mobile

You can connect your mobile to the conference module by using the Lightning, 30 pin and micro-USB adapters. A Bluetooth® connection is needed to place and receive your mobile calls on the Alcatel-Lucent 8125 Audiooffice. To receive and end a voip call, use your Alcatel Lucent softphone application.

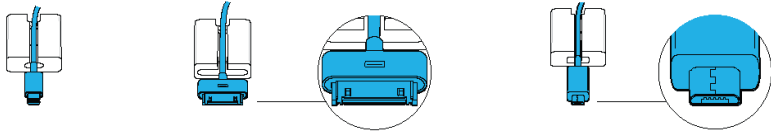
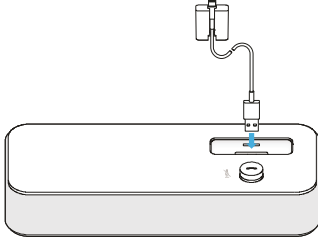
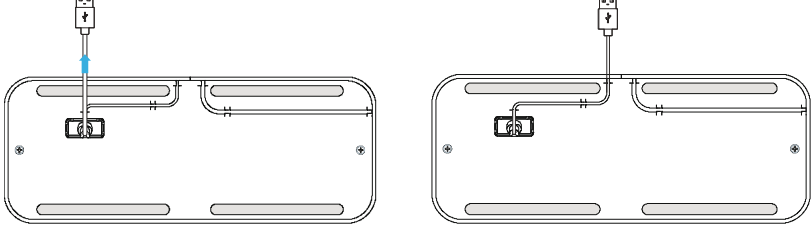
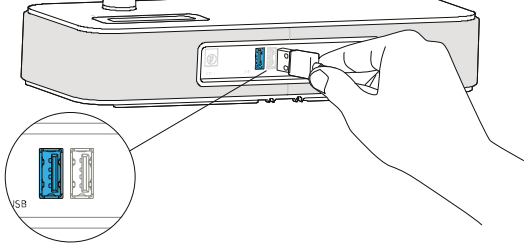
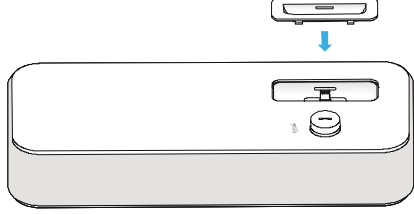
<p>Insert the cable suitable to your smartphone into the matching cable adapter. Place the cable in the cable hole.</p>	
<p>Slide the cord into place through the interstices under the base.</p>	
<p>Slide the cord into place through the interstices under the base.</p>	
<p>Plug the USB connector to the left USB port at the rear of the device.</p>	
<p>Insert the suitable adapter to your smartphone, or none if you use a case and your device doesn't fit.</p>	

## 8.4 USB external ringing interface module (USB Interface module 2 relays 3GV28184AA)

	8078s CE	8068s CE	8058s CE	8018 CE	8008/8008G CE
The accessory is supported by the following sets	●	●	●		

The USB external ringing interface module allows driving an external system (like a ring or a lamp), following the ring tone cadence or the communication state of the phone connected on the telephone line. No system configuration is requested to install the module.

USB Interface module 2 relays lets to connect directly one or 2 external ringings on the USB connector of your deskphone:

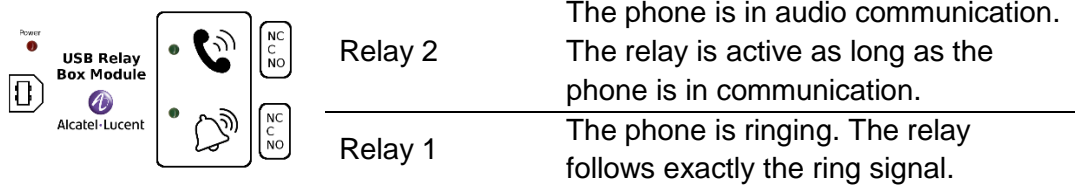

### List of supplies

- USB external ringing interface module.
- 1 USB cable 1,5 m (4,9 feet) USB type A - USB type B.

### 8.4.1 Installation

**WARNING:** The module must be closed before use. No settings require the module to be open.

In idle state:

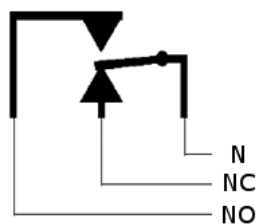

Ringing or during communication:

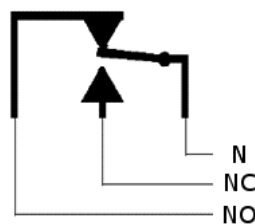

N: Common.  
NC: active signal.  
NO: non-active signal.

Typical usage diagram:

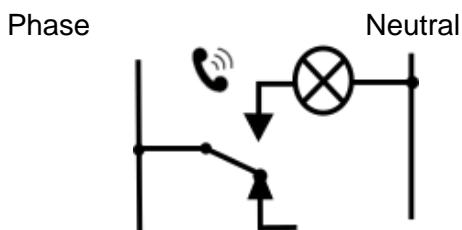

The lamp lights up when the phone is in communication.

The breaking capacity is 12V/24V DC 15A or 120V/220V AC at 10A.

## 8.4.2 Connect the device



- Plug the provided cord USB type B on the USB connector of the module.
- Plug the provided cord USB type A on the USB connector of the deskphone. See description of the connectors of your phone.





## 8.5 External ringing interface module (MWS 3GV28050AA)

	8078s CE	8068s CE	8058s CE	8018 CE	8008/8008G CE
The accessory is supported by the following sets	●	●	●		

You have to use a RJ11 to SATA adapter to connect your deskphone to this device. The RJ11 to SATA adaptator is sold separately (3MG07058AA).

The external ringing interface module allows driving an external system (like a ring or a lamp), following the ring tone cadence of the phone set connected on the telephone line. A switch on the electronic board allows selecting between 2 operation modes.

-  Follows the cadence: the relay follows exactly the ring signal.
-  Hold mode: the relay is held for 0,7 s after the ring signal is gone. It erases some of the ring pulses.

### 8.5.1 List of supplies

- 1 external ringing interface module.
- 3 circuits plug to screw.
- 1 RJ11/RJ11 3 meters (10 feet) cable.
- 1 DC Japan/DC Japan 3 meters (10 feet) power cable.

A power supply may be required to power the module when used with IP phone powered remotely (Power Over Ethernet).

Use only the following power supply (Sold separately):

- 3AK27097 (commercial part number).
- 1AF00446 (technical part number).

### 8.5.2 Installation

**WARNING:** The module must be closed before use. No settings require the module to be open.

In idle state:

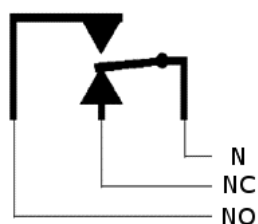



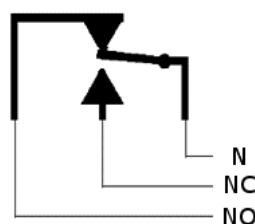

The phone is ringing:



N: common.  
NC: active signal.  
NO: non-active signal.

### 8.5.3 Connect the device



<b>Phone set connected over IP and to an external power supply</b>		
<b>1</b>	Connected to the DC power jack of the deskphone by using DC Japan cable.	
<b>2</b>	Connected to the power supply of the device.	
<b>3</b>	Connected to the SATA connector of the deskphone, by using the RJ11 cable with an adpatator RJ11 to SATA. The RJ11 to SATA adaptator is sold separately.	 SATA
<b>Phone set connected over IP and PoE</b>		
<b>1</b>	Connected to the DC power jack of the deskphone by using DC Japan cable.	
<b>2</b>	Connected to the power supply of the device.	
<b>3</b>	Connected to the SATA connector of the deskphone, by using the RJ11 cable with an adpatator RJ11 to SATA. The RJ11 to SATA adaptator is sold separately.	 SATA

## 8.6 Wall mounting kit

### 8.6.1 8068s, 8058s Cloud Edition Deskphone

**1**

1. Rotate the metal foot to flat.
2. Remove the rubber cover on phone back shell each side.

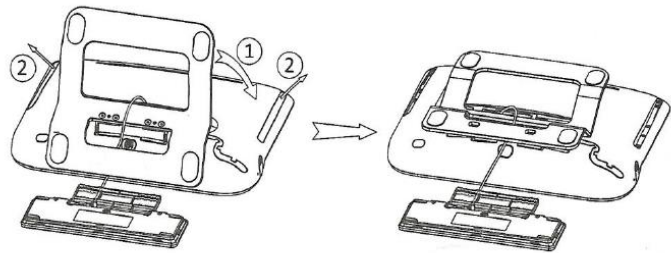

**2**

1. Drill two holes on the wall (separation=90mm, diameter=6mm).
2. Insert the fastener into the holes on wall (P/N: 1AD007550003).
3. Fix the support with both screws and adjust (P/N: 1 1AD007460003). The support is used as a reference and must be removable.

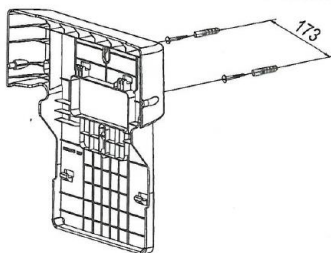

**3**

1. Put the support on the back side of the phone.
2. Slide it to top side and make sure the 4 hooks hold the metal foot.
3. Attach the magnetic alphabetic keyboard to the metal foot.
4. Push on the two corners of mini-keyboard to fix it in the support.

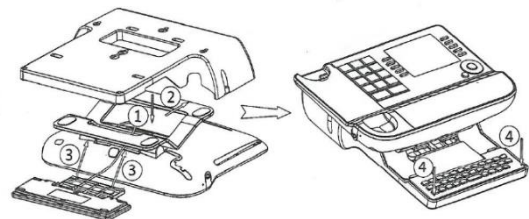

**4**

1. Fix the support with the phone by 1 screw (P/N: 1AD100020003).
2. Connect cables through the hole on support left side or right side.

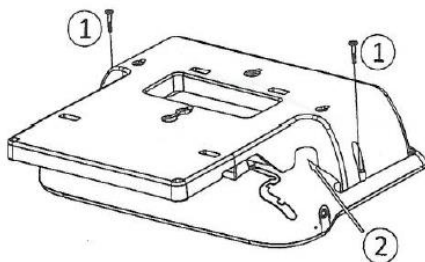

To connect ethernet, use RJ45 cable (P/N: 1AB045210162).  
To connect the power, use extension cable (P/N: 1AB203010001).

**5**

1. Hang the assembled phone with support on the wall.

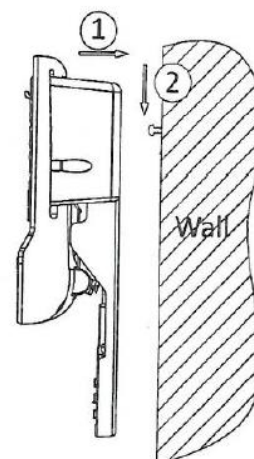

### 8.6.2 8018 Cloud Edition DeskPhone

1

1. Drill two holes on the wall (separation=90mm, diameter=6mm).
2. Insert the fastener into the holes on wall (P/N: 1AD007550003).
3. Fix the support with both screws and adjust (P/N: 1 1AD007460003). The support is used as a reference and must be removable.

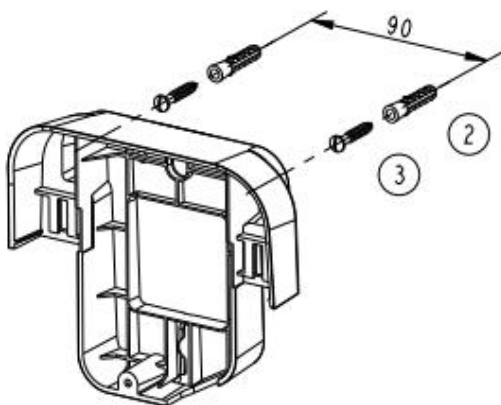

2

1. Put the support on the back side of the phone.
2. Slide it from top side and make sure the 2 snaps are engaged on the shell.

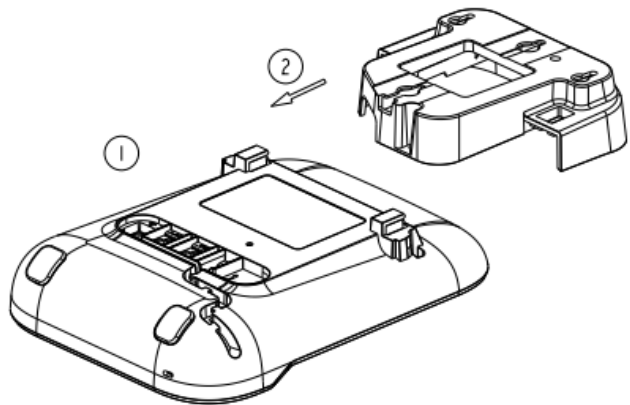

3

1. Fix the support with the phone by 1 screw (P/N: 1AD204430001).
2. Connect cables through the hole on support bottom side.

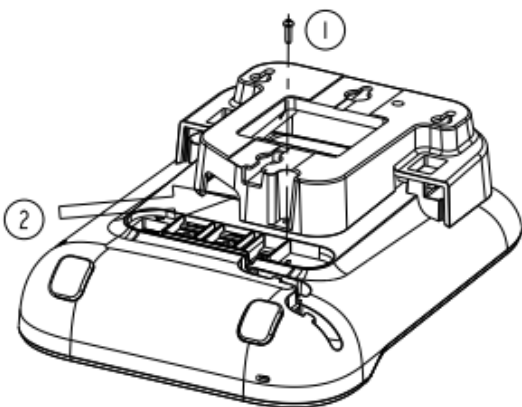

4

1. Hang the assembled phone with support on the wall (P/N: 1AB045210162).

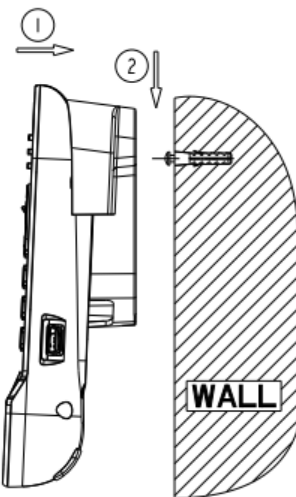

5

If the handset doesn't fit on the phone when it is hooked to the wall, you can turn the clip on the phone as shown in the following picture:

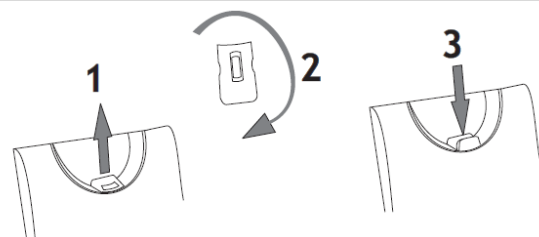

### 8.6.3 8008/8008G Cloud Edition DeskPhone

#### Installation of the wall mount kit

1

Fix the wall mount kit on the wall by using the 4 provided screws and nylon anchors. You can use the support as a reference to mark position. Remove it before drilling holes.

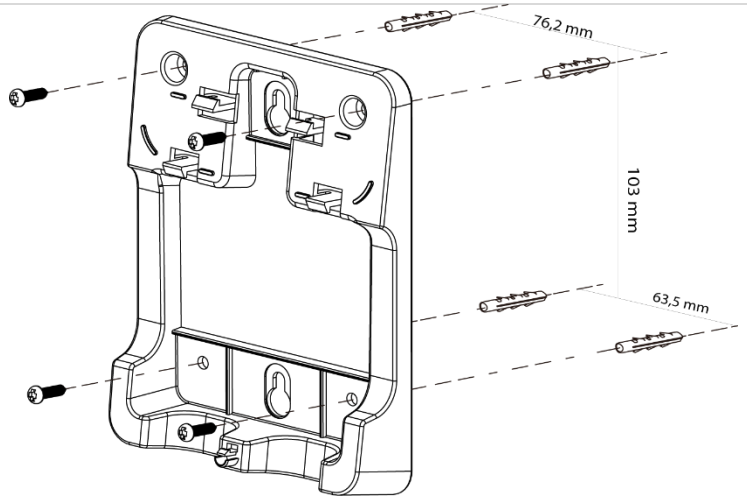

2

Assemble the phone with the wall mount kit by using the 5 hooks of the support.

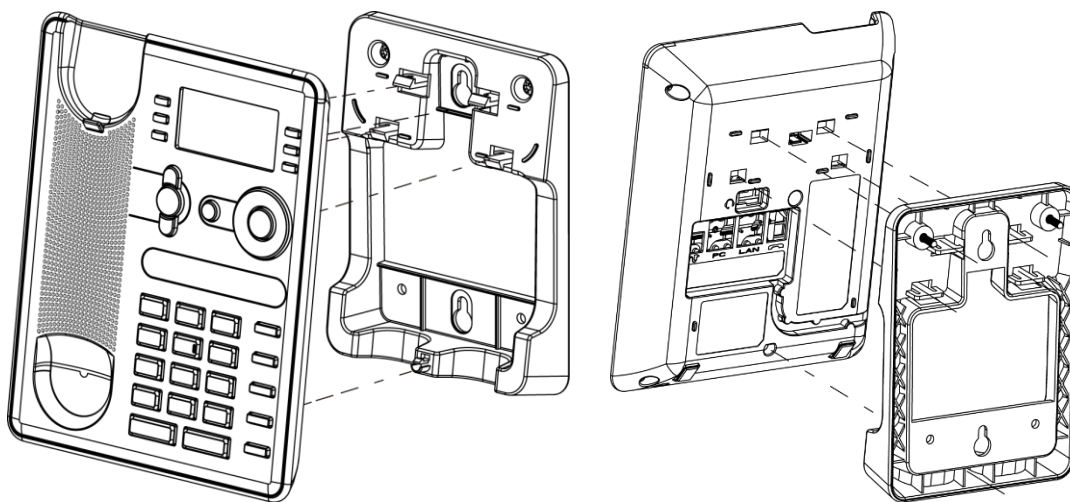

#### Pull out the phone from the support

1. Maintain the support with one hand by using the two holes on the bottom of the wall mount kit.
1. With the other hand, pull out the phone from the support as shown in the image.

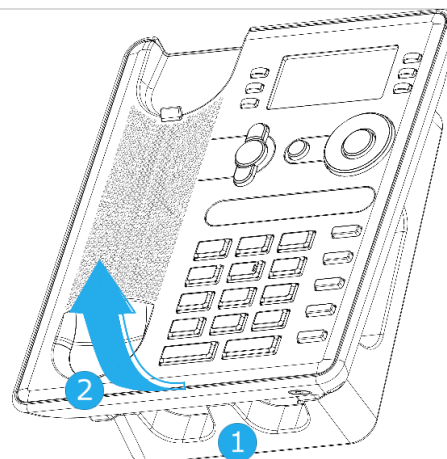

## 8.7 Connect a 3 pole jack headset

Your phone is equipped with a 3.5 mm, 4 pole jack. If your headset is not compatible (3 pole jack), you have to use adapters.

Use the following kit which contains a 3 pole to 4 pole jack adapter and a RJ11 to SATA adapter:

- 80XX JACK 4-3 POLE CABLE (box of 10) 3MG08018AA
- 80x8S SATA-RJ11 CABLE (box of 10) 3MG08019AA

<b>1</b>	A 3 pole to 4 pole jack adapter to connect the jack of the headset to the DeskPhone to manage audio.
<b>2</b>	RJ11 to SATA adapter to connect the RJ11 connector of the headset to the SATA connector to the DeskPhone to manage ringing. Some manufacturer provides the Sata connector. In this case, the adapter is not useful.
<b>3</b>	EHS adapter (depends on accessory manufacturer).

For example:

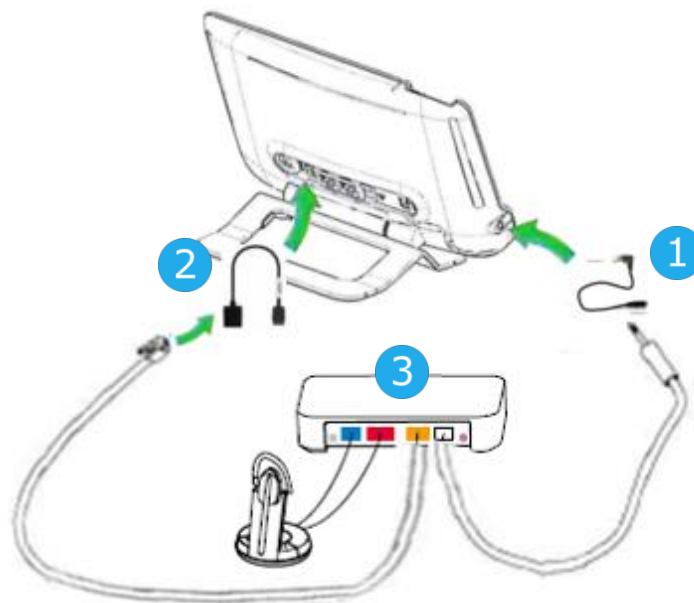

## 8.8 Alcatel-Lucent Enterprise Application Partner Program

The mission of the Alcatel-Lucent Enterprise Application Partner Program is to support a broad ecosystem of developers and partners throughout the deskphone Lifecycle. In this context, certification tests are made between applications or devices of partners and Alcatel-Lucent Enterprise's platforms. It certifies proper inter-working with applications or devices of the partner. Results of certification tests for headsets can be consulted by following links below.

- IWR-0121: Sennheiser Headsets / Desk phones  
<https://www.al-enterprise.com/en-en/-/media/assets/internet/documents/iwr-0121-sennheiser-headsets-ale-terminals-en.pdf>
- IWR-0018: Jabra Headsets for hardphones  
<https://www.al-enterprise.com/en-en/-/media/assets/internet/documents/iwr-0018-ed03-gn-jabra-headsets-amplifiers-omnipcxplatformsterminals.pdf>
- IWR-0164: Plantronics-Headsets-Amplifiers  
<https://www.al-enterprise.com/en-en/-/media/assets/internet/documents/plantronics-headsets-amplifiers-iwr-0164-ed04.pdf>



## 9 Technical specifications

	<b>8078s CE</b>	<b>8068s CE</b>	<b>8058s CE</b>
Width	252 mm (9,92 in)	252 mm (9,92 in)	252 mm (9,92 in)
Depth on a table	200 mm (7,87 in)	200 mm (7,87 in)	200 mm (7,87 in)
Height	204 mm (8,03 in)	204 mm (8,03 in)	204 mm (8,03 in)
Weight	1450 g	1350 g	1350 g
Adjustable foot stand range	25° - 60°	25° - 60°	25° - 60°
Color	Moon grey	Moon grey	Moon grey
Display	5 inch capacitive touch color, 480 x 800 pixels, effective display area size 108.00 x 64.80 mm	3.5 inch color, 240 x 320 pixels, effective display area size 70.08 x 52.56 mm	3.5 inch color, 240 x 320 pixels, effective display area size 70.08 x 52.56 mm
Power over Ethernet (IEEE 802.3af)	Class 2	Class 2	Class 2
Power consumption (PoE) Idle – Active(w/o Add-on, w/o USB)	2.1 W – 3.5 W	2 W - 3.1W	1.6 W – 2.2 W
Operating conditions	-5°C - +45°C (23°F - 113°F)	-5°C - +45°C (23°F - 113°F)	-5°C - +45°C (23°F - 113°F)

	<b>8018 CE</b>	<b>8008/8008G CE</b>	
Width	164 mm (6.46 in)	150 mm (5,91 in)	
Depth on a table	200 mm (7.87 in)	34,8 mm (1,37 in)	
Height	170 mm (6.69 in)	195 mm (7,68 in)	
Weight	675 g (1.48 lbs)	508 g (1,12 lbs)	
Adjustable foot stand range	45°	45°	
Color	Moon grey	Moon grey	
Display	2.4 inches 128 x 64 pixels graphic black/white LCD display, effective display area size 54.8 x 28.5 mm (2.15 x 1.12 in)	2.4 inches 128 x 64 pixels graphic black/white LCD display, effective display area size 52 x 26 mm (2.05 x 1.02 in)	
Power over Ethernet (IEEE 802.3af)	Class 1	Class 1	
Power consumption (PoE) Idle – Active(w/o Add-on, w/o USB)		Power supply: Optional accessory	
Operating conditions	-5°C - +45°C (23°F - 113°F)	-5°C - +45°C (23°F - 113°F)	

	<b>USB external ringing interface module (3GV28184AA)</b>	<b>8115 Audiooffice</b>	<b>8125 Audiooffice</b>	<b>8105s EGO</b>
Maximum distance between the phone set and the device	1,5 m (5 feet)			
Width	100 mm (3,9 in)	290 mm (11,4 in)	290 mm (11,4 in)	145 mm (5,7in)
Depth on a table	62 mm (2,4 in)	114 mm (4,5 in)	114 mm (4,5 in)	135 mm (5,31in)
Height	26 mm (1 in)	53 mm (2,1 in)	53 mm (2,1 in)	32 mm (1,26in)
Weight		1497g (3,3 lbs)	1497g (3,3 lbs)	230 g (0,51 lb)
Adjustable foot stand range				
Color		Black	Black	Licorice black
Power consumption				
Power consumption	15A 12/24Vdc 10A 120/220Vac	100-240V / 12V 3A AC	100-240V / 12V 3A AC	Battery: 1000 mAh Li-ion AC adapter: Power and charging via USB.
UL/CSA Ratings				
Operating conditions		0°C – 40°C (32 °F - 104 °F)	0°C – 40°C (32 °F - 104 °F)	5° C à 40° C (41 °F - 104 °F)

# 10 Ordering information

8008 Cloud Edition DeskPhone	3MG08010CE
8008G Cloud Edition DeskPhone	3MG08021CE
8008 Wall mounting kit	3MG02013AA
8008 Power adaptor	3MG08011AA
QD RJ9 adapter	3GV28177AA
8018 Cloud Edition DeskPhone	3MG27201CF
8018 Wall mounting kit	3MG27210AA
8018 Customizable clip (x10)	3MG27211AA
8018/8019S paper label + cover kit (x10)	3MG27222AA
8018/8019s Paper label (x64)	3MG27215AB
8018 Plastic foot (x10)	3MG27216AA
8058s Cloud Edition Deskphone	3MG27203CE
8068s Cloud Edition Deskphone	3MG27204CE
8078s Cloud Edition Deskphone	3MG27205CE
Premium Add-on 10 keys module	3MG27105AC
Premium Add on 10 key modules paper labels (x64)	3MG27115AA
Premium Smart displays 14 keys module with clip	3MG27107AC
Premium Add-on 40 keys module with clip	3MG27106AC
Premium Add-on 40 keys module paper labels (x50)	3MG27116AA
80XX JACK 4-3 POLE CABLE (x10)	3MG08018AA
80x8S SATA-RJ11 CABLE (x10)	3MG08019AA
USB C to USB-A cable (box of 10)	3MG08020AA
Wide Band Comfort Handset	3MG27032AA
Wide Band Bluetooth Handset	3MG27209AA
Corded Premium Monaural Wideband Headset	3GV28047BA
Corded Monaural Wideband Headset	3GV28047AD
Corded Monaural	3BN78158AB
Corded Premium Binaural Wideband Headset	3GV28048BA
Corded Binaural Wideband Headset	3GV28048AD
Bluetooth Monaural Headset	3BN67215WW
USB Binaural Headset	3GV28057AB
Magnetic Alphabetic Keyboard	3MG27208xx
Premium Wall Mounting Kit	3MG27110AA
AC/DC Power Adapter (100–240 V AC/48 V DC)	3MG27006xx
Dongle USB OmniAccess Stellar BLE (box of 10)	OAL_PT_USB_10
8105s EGO	3MG08017AA
8135s IP Conference Phone	3MG07040AA
Conference Module 8115 Audiooffice	3MG08001AA
Conference Module 8125 Audiooffice	3MG08002AA
External ringing interface module without PSU	3GV28050AA
USB external ringing interface module	3GV28184AA

# 11 Guarantee and clauses

Current Safety and Regulatory Statements relate to the following products (do not apply to accessories): 8078s Cloud Edition DeskPhone, 8068s Cloud Edition DeskPhone, 8058s Cloud Edition DeskPhone, 8018 Cloud Edition DeskPhone, 8008G Cloud Edition DeskPhone, 8008 Cloud Edition DeskPhone.

## 11.1 Safety Instructions

- Changes or modifications to the equipment not expressly approved by the party responsible for compliance could void the user's authority to operate the equipment.
- Magnets could affect the functioning of pacemakers and implanted heart defibrillators. Keep a safe distance between your pacemaker or implant defibrillator and the handset which includes magnetic elements: 4 centimeters (1,6 inches) at least.
- To limit the risk of interference, people with pacemakers must keep the wireless telephone away from their equipment (minimum distance of 15 cm/6 inches).
- It is recommended to follow the standard acceptance procedures before using this equipment in human safety critical areas (hospitals...).
- The handset includes magnetic elements that may attract sharp metallic objects. To prevent injury, before each use ensure sharp metallic objects are not stuck to the earpiece and microphone.
- A Bluetooth® Handset with integrated battery is available with certain Product variants. The battery must be charged during 6 hours before initial use and must be replaced correctly to prevent danger of explosion. Use only the recommended battery. Contact your Business Partner if you need a spare battery.
- Avoid using phones (other than cordless type) during an electrical storm. There may be a remote risk of electric shock from lightning.
- Do not use the device in environments where there is a danger of explosion.
- Do not plug this phone into an Integrated Services Digital Network (ISDN) connection or into a regular Public Switched Telephone Network (PSTN) connection. This can result in severe damage to the phone.
- Never allow your telephone to come into contact with water.
- To clean your telephone, use a soft damp cloth. Never use solvents (trichlorethylene, acetone, etc.) which may damage the plastic parts of your telephone. Do not use aerosol cleaners.
- This product is intended to be supplied, either via the Ethernet (LAN) port, or via the DC-in by a Certified Direct Plug-In Power Unit approved as 'LPS' (Limited Power Source) against CSA/UL/IEC 60950-1 and rated 48V dc, minimum 0.27A. allowed power supplies: WA-13B48R – Asian Power Devices Inc.
- Some DeskPhones also offer a Bluetooth® radio interface for Bluetooth® handsets or other Bluetooth® devices with the frequency range 2402-2480 MHz and radiated power 5 mW.
- If you are connected to a POE connection do not use an external Power Supply.
- The cover of the phone screen is made of glass. This glass could break if the phone is dropped or it receives a significant blow. If the glass chips or cracks, stop using the phone and do not touch the broken glass as this could cause injury to you. Glass cracked due to misuse or abuse is not covered under the warranty.

## 11.2 Regulatory Statements

### EUROPE

This equipment complies with the essential requirements of following directives: 2014/30/EU (EMC), 2014/35/EU (LVD), 2009/125/EC (ErP), 2011/65/EU (RoHS).

Declaration of Conformity may be obtained from:

ALE International 32 avenue Kléber – 92700 Colombes, France  
ebg\_global\_supportcenter@al-enterprise.com

### USA and Canada

Phones with Bluetooth® comply with Industry Canada's license-exempt RSSs. Operation is subject to the following two conditions: (1) this device may not cause harmful interference, and (2) this device must accept any interference received, including interference that may cause undesired operation. This equipment has been tested and found to comply with the limits for a class B digital device, pursuant to Part 15 of the FCC Rules. These limits are designed to provide reasonable protection against harmful interference in a residential installation. This equipment generates, uses and can radiate radio frequency energy and, if not installed and used in accordance with the instructions, may cause harmful interference to radio communications. However, there is no guarantee that interference will not occur in a particular installation. If this equipment does cause harmful interference to radio or television reception, which can be determined by turning the equipment off and on, the user is encouraged to try correcting the interference by consulting the dealer.

### Exposure to Radio Frequency Signals

This equipment complies with radiation exposure limits set by FCC/IC and the Council of European Union for an uncontrolled environment. This equipment has very low levels of RF energy and is deemed to be compliant without testing of the specific absorption rate (SAR).

### User Instructions

Use this product in temperatures between -5°C to +45°C (23°F to 113°F).

This product is intended for use in an indoor environment only. This apparatus is Hearing Aid Compatible (HAC).

### Acoustic shock protection

Maximum sound pressure level for handset is compliant with European, US and Australian standards.

#### Directive 2003/10/EC specifying the risks inherent in noise at work

The ring contributes towards overall daily noise - at its maximum setting, the level is 105 dBA at 60 cm from terminal. To reduce the level, the following is recommended:- reduce the setting (9 levels of 5 dB) - program a progressive ring.

### Privacy

Privacy of communications may not be ensured when using the Bluetooth® handset or any additional Bluetooth® device.



### Disposal

The equipment must be returned to a collection point for electronic equipment waste disposal. Defective batteries must be returned to a collection point for chemical waste disposal.

### Related Documentation

Other languages for these Safety and Regulatory Instructions and User Documentation are available at the following Web site:









<https://www.al-enterprise.com/products>.









The Alcatel-Lucent name and logo are trademarks of Nokia used under license by ALE.





To view other trademarks used by affiliated companies of ALE Holding, visit:















[www.al-enterprise.com/en/legal/trademarks-copyright](http://www.al-enterprise.com/en/legal/trademarks-copyright). All other trademarks are the property of their respective owners. The information presented is subject to change without notice. Neither ALE Holding nor any of its affiliates assumes any responsibility for inaccuracies contained herein.





© 2019 ALE International. [www.al-enterprise.com](http://www.al-enterprise.com).

Features keys	
<ul style="list-style-type: none"> <li>Mute key During a call, press this key to stop your contact from hearing you.</li> </ul>	
<ul style="list-style-type: none"> <li>Turn down the volume (ringing or call state).</li> <li>Decrease the brightness (idle state).</li> <li>Decrease the contrast (idle state).</li> </ul>	
<ul style="list-style-type: none"> <li>Turn up the volume (ringing or call state).</li> <li>Increase the brightness (idle state).</li> <li>Increase the contrast (idle state).</li> </ul>	
<ul style="list-style-type: none"> <li>Pressing this key answers an incoming call in hands-free mode (when activated, the key is lit blue). When a call is in progress, pressing this key switches from hands-free mode to headset or handset mode.</li> </ul>	
<ul style="list-style-type: none"> <li>The F1 and F2 keys are line keys. Can be used to answer to an incoming call or switch from one call to another.</li> </ul>	
<ul style="list-style-type: none"> <li>Last number redial. For the phones 8018/8008G/8008 Cloud Edition DeskPhone, the redial key is associated with the Off-hook key when the phone is in idle state: .</li> </ul>	
<ul style="list-style-type: none"> <li>Information about the user: lastname, firstname, phone number,.. (short press).</li> <li>Switch between the alphabetic and numeric keyboards (long press)</li> </ul>	
<ul style="list-style-type: none"> <li>Access the voice mail The message key flashes when you have received a new voicemail</li> </ul>	

Homepage screen	
<p>The homepage is the default page displayed on your phone. The default homepage shows information about the phone (name, number, number of missed calls, number of new messages, forwarding status), but this can be changed in the phone settings.</p> <p>Depending on the type of your phone, you can navigate in the title bar by pressing on it or by using the right navigation key. Icons depend on the theme (skin) of the phone.</p>	
	Display all information about the phone: name, number, number of missed calls, number of new messages, forwarding status. The icon is marked with a red dot if there is one or more new event.
	Access to the calls log. The number of new events are displayed (number of missed calls + number of unread messages).
	Access the forwarding configuration.
	Access the voicemail. The number of new voice messages is displayed.
	Access the local directory.
	Access the settings.
	Lock/unlock the phone.
	Access to personal speed dial.

Call icons			
	Incoming call icon: this icon blinks when there is another incoming call.		Conference icon.
	Call in progress icon.		End of call icon. your contact ended the conversation.
	Call holding icon: this icon blinks when there is another ongoing call.		

Alpha-numeric keyboard																																																	
<ul style="list-style-type: none"> <li>Depending on the phone type, you can switch between the alphabetic and numeric keyboards by pressing the following key:                             <ul style="list-style-type: none"> <li> (long press): when the alphabetic mode is activated, this icon is displayed in the top bar of the screen: .</li> <li> (short press): when the alphabetic mode is activated, the light corresponding to the key remains lit up.</li> </ul> </li> <li>When the alphabetic mode is activated, the light corresponding to the key remains lit up.</li> <li>Enter alphabetic characters. The number pad keys have letters that you can display by successive presses. The number is the last character in the series. Some special characters can be displayed by successively pressing the key:</li> </ul>	<table border="1"> <tbody> <tr> <td></td> <td>%</td> <td>\$</td> <td>/</td> <td>~</td> <td>&amp;</td> <td>(</td> <td>)</td> <td>[</td> <td>]</td> <td>=</td> <td>*</td> </tr> <tr> <td></td> <td>@</td> <td>#</td> <td></td> <td></td> <td></td> <td></td> <td></td> <td></td> <td></td> <td></td> <td></td> </tr> <tr> <td></td> <td></td> <td>space</td> <td>-</td> <td>_</td> <td>1</td> <td></td> <td></td> <td></td> <td></td> <td></td> <td></td> </tr> <tr> <td></td> <td>+</td> <td>.</td> <td>,</td> <td>;</td> <td>:</td> <td>/</td> <td>\</td> <td>?</td> <td>!</td> <td>0</td> <td></td> </tr> </tbody> </table>		%	\$	/	~	&	(	)	[	]	=	*		@	#												space	-	_	1								+	.	,	;	:	/	\	?	!	0	
	%	\$	/	~	&	(	)	[	]	=	*																																						
	@	#																																															
		space	-	_	1																																												
	+	.	,	;	:	/	\	?	!	0																																							

Magnetic alphabetic keyboard (optional)	
Cursor moving keys (left, right, up and down). Allows you to navigate edit boxes. Press the Alt key to access the left and up directions.	
Caps lock: to write text in capital letters.	
Alt key: to access specific and punctuation characters.	
Enter key: to validate edited text.	
Backspace key: to delete one character in an edit box.	



## Local directory

- Select the local directory icon from the phone menu (see the navigation section of your phone model).
- Press the menu key or the ok key to open the menu.
- Call your contact / Create a new contact / Delete the selected contact / Delete all contacts in the local directory / Modify a contact.

## Calling by number

You can unhook the handset or the headset to make a call with the handset or the headset otherwise you make a call in hands-free mode.

Dial the number directly and press: / OR

## Calling by name

- Enter the first letters of your contact's name.
- Start the call.

## Call from call log

- Select the history icon from the phone menu (see the navigation section of your phone model).
- Using the up and down navigator (if necessary), find the contact to call.
- Press the relevant callback key in the Call Log (right side).

## Make a call using the local directory

- Select the local directory icon from the phone menu (see the navigation section of your phone model)
- Call the contact by pressing the call icon key.

## Answer a call

- Lift the handset or use an answer keys / / / .

## Reject or deflect an incoming call

- *Reject call* OR Reject the call. The incoming call is ended.
- *Deflect* Deflect the call to another contact:
- *Deflect VM* Deflect the call to your voicemail.

## Redialing

- Redialing the last number dialed (redial).

## Placing a call on hold

- *Put on hold* The call is placed on hold ().
- *Retrieve* Recover the call on hold. You can resume the conversation ().

## Sending DTMF signals

- Enter DTMF code.

## Mute, so that your contact cannot hear you

- Disable microphone the mute key blinks.

## Making a second call during a conversation

- Press the key associated with the icon: *New call*.
- Call your contact using the dial by name or the dial a number feature.
- Press the call icon key the first call is on hold.

## To cancel your second call and recover the first

- Hang up.
- *Retrieve*  
 you are on the line with your first contact.

## Answering a second call during a conversation

- Press the 'take the call' key the first call is on hold.
- As long as the call is presented, you can also choose to deflect the call.

## Switching between calls (Broker call)

Use one of the following:

- Press the blinking line key
- Using the left-right navigation keys, select the blinking 'call on hold' icon ().

*Retrieve*

## Transferring a call

- During a conversation.
- *Transfer to*
- Call the recipient of the transfer using the dial a number or dial by name feature.  
The transfer is done as soon as the call is started.

## Conference

- Call the first contact.
- Call the second contact.
- *Conference* you are in conference mode.

## Consulting your voice mailbox

- Press the messaging key.

## Adjust audio volume



## Selecting language

- Select the settings icon from the phone menu (see the navigation section of your phone model).
- *Phone* *Language*.
- Select the language of your choice.

## Adjusting the audio functions

- Select the settings icon from the phone menu (see the navigation section of your phone model).
- *Phone* *Ringtone*
  - *Melody*: select the melody.
  - *Level*: adjusting the ringer volume.
  - *Ringtone mode*: configure the ringtone.

## Configuring the welcome page

- Select the settings icon from the phone menu (see the navigation section of your phone model).
- *Phone* *homepage*
  - *Default*: select the default page.
  - *Hide/display*: select displayed tabs.
  - *Order*: set the displayed order of the tabs.

## Adjusting the brightness of the deskphone

- Select the settings icon from the phone menu (see the navigation section of your phone model).
- *Phone* *Display*
  - *Brightness*: adjust the brightness when the phone is in use.
  - *Low brightness*: adjust the dimmed brightness when the phone is not in use.
  - *Screensaver*: set the delay before the screensaver starts.

## Forwarding to a number or voicemail

- Select the forwarding icon from the phone menu (see the navigation section of your phone model) / Select the forward icon from the information tab.
  - *Deactivate*  
When selecting this option, no forward is activated.
  - *Immediate*  
All your calls are immediately forwarded to another set or voicemail.
  - *No Reply*  
All your calls are forwarded to another set or voicemail when you cannot answer.
  - *Busy*  
All your calls are forwarded to another set or voicemail when you are already on the line.
  - *Busy/No Reply*  
All your calls are forwarded to another set or voicemail when you cannot answer or when you are already on the line.
- use one of the following:
  - *Voicemail*: forward your calls to voicemail.
  - *User*: forward your calls to another set.
- Select the forwarding destination by dialing directly the number.