



H3P/H3G/H6 DeskPhone User Manual

Version 1.0

June, 2021

Alcatel·Lucent 
Enterprise

Introduction

Thank you for choosing an Alcatel-Lucent Enterprise phone.

This document describes the services offered by the H3P, H3G and H6 DeskPhones connected to an ALE SIP server.



H3P DeskPhone



H3G DeskPhone



H6 DeskPhone

The phones described in this document are supported on different SIP servers, and some features described in this document depend on the SIP server to which the phone is connected. If more information about system compatibility or about the level of features for a given SIP server is needed, please contact your system administrator.

The labels and icons displayed depend on the type and the skin of the set. The label will not be displayed if the corresponding feature is not configured on your telephone system. Depending on the size of the display, some labels may be truncated.

The main features of the phones are listed as follows:

	H3P	H3G	H6
Multiple accounts (H3P/H3G 3, H6:4)	●	●	●
2.8-inch color screen			●
2.8-Inch black-and-white screen	●	●	
Adjustable screen brightness	●	●	●
Adjustable phone angle	●	●	●
HD handset	●	●	●
RJ9 headset	●	●	●
USB headset			●
Wi-Fi dongle compatible			●
Dual 100 Mbps Ethernet ports (POE)	●		
Dual 1000 Mbps Ethernet ports (POE)		●	●
External power supply	●	●	●
Wall-mounted	●	●	●
Switching among multiple audio modes	●	●	●
Local 5-party conference	●	●	●
IP Call	●	●	●
Web management	●	●	●
OpenVPN	●	●	●
Easy Deployment Server (EDS)/ Easy Provisioning Server (EPS)	●	●	●

1	Getting to know your desk phone	7
1.1	Packaging list	7
1.2	Installing your desk phone	7
1.2.1	Installing the foot	7
1.2.2	Connecting your desk phone	8
1.2.3	Installing a wired handset	8
2	Getting to know your telephone	9
2.1	H6 DeskPhone	9
2.2	H3P/H3G DeskPhone	10
2.3	Main screen	11
2.4	Call management interface	12
2.5	Navigation key	12
2.6	Permanent function keys	13
2.7	Programmable key icons	14
2.8	Telephone status/Call icons	15
2.9	Alpha-numeric dialpad	15
2.10	Desk phone connectors	17
3	Using your telephone	18
3.1	Information about the phone	18
3.1.1	Information about the events	18
3.1.2	Information about the phone status	18
3.2	Multiple SIP Accounts	19
3.2.1	Configuring the programmable keys for an account	19
3.2.2	Defining the default SIP Account	19
3.3	Making a call	19
3.3.1	Opening the dialer	20
3.3.2	Dialing the phone number	20
3.3.3	Calling by name	21
3.3.4	Calling from the call log	21
3.3.5	Calling using your personal directory	22
3.3.6	Calling using Speed Dial key	22
3.3.7	Making a peer to peer SIP call	22
3.4	Receiving a call	23
3.5	Switching between audio modes	23
3.6	Redialing	24
3.6.1	Redial list	24
3.7	Directory management	24
3.7.1	Contacts	24
3.7.2	Contacts management	24
3.7.3	Calling your contact	25
3.7.4	Creating a new contact	26
3.7.5	Creating a new group	26
3.7.6	Modifying a contact	26
3.7.7	Delete a contact.	27
3.7.8	Deleting all contacts	27
3.7.9	Deleting a group in the local directory	27

3.7.10	Deleting all groups in the local directory	27
3.8	Managing the call log (history)	28
3.8.1	Calling a contact	29
3.8.2	Displaying missed calls only	29
3.8.3	Deleting the call log of a contact	29
3.8.4	Clearing the call log	29
3.9	Managing speed dial	30
3.9.1	Creating a Speed Dial key	30
3.9.2	Making a call using speed dial	30
3.10	Sending DTMF signals	30
3.11	Muting the microphone, so that your contact cannot hear you	31
3.12	Auto answer	31
3.13	Making an intercom call	31
3.14	Configuring intercom calls	32
3.15	Changing a PIN code	32
3.16	Locking/Unlocking your desk phone	33
3.16.1	Locking your desk phone	33
3.16.2	Unlocking your desk phone	33
3.16.3	Activating or deactivating the automatic keypad lock	33
3.17	During a conversation	34
3.18	Making a second call during a conversation	34
3.19	Answering a second call during a conversation	35
3.20	Canceling your second call and resuming the first call	35
3.21	Placing a call on hold	36
3.22	Switching between calls	36
3.23	Transferring a call	36
3.23.1	Transferring a call to another contact on hold	36
3.23.2	Transferring your call to another contact	37
3.23.3	Blind transfer	38
3.24	Three-party conference	38
3.24.1	End conf	38
3.24.2	Leaving your two contacts talking together after the conference	39
3.25	Five-party conference	39
3.25.1	End conf	39
3.26	Hiding your phone number	40
3.27	Rejecting anonymous calls	40
3.28	Do not disturb (DND)	41
3.29	Call Forward	41
3.30	Canceling call forwarding	42
3.31	Listening to your voice messages	42
3.32	Defining a hotline number	42
4	Doing more with your desk phone	44
4.1	Configuring your desk phone for remote working	44
4.2	Connecting your H6 DeskPhone to the Wi-Fi	45
4.2.1	Configuring the wireless network	45
4.2.2	Managing wireless networks	46
4.3	Hot Desking	48

4.3.1	Log on to Hot Desking	48
4.3.2	Log off from Hot Desking	48
5	Customizing your desk phone	49
<hr/>		
5.1	Adjusting the audio features	49
5.1.1	Selecting the ringing	49
5.1.2	Adjusting the ringing volume	49
5.1.3	Configuring the ring mode	50
5.1.4	Configuring the beep mode	50
5.1.5	Configuring the seat mode	50
5.2	Selecting a language	51
5.3	Adjusting the brightness of the desk phone	51
5.4	Enabling the Screen Saver and defining the Wait Time	52
5.5	Configuring the background picture for your H6 DeskPhone	52
5.6	Configuring the homepage format	52
5.7	Defining the voicemail number	53
5.8	Programmable keys	54
5.8.1	Creating a programmable key	54
5.8.2	Deleting a programmable key	54
5.8.3	Type of supported programmable keys	54
5.9	Call pick-up	56
5.10	Activating the headset mode	56
5.11	Defining Time and Date format	57
6	Contacting your administrator (technical support)	58
<hr/>		
6.1	Technical code / Date code	58
6.2	Viewing the software version/network settings (IP address)	58
6.3	Accessing administrator configuration	59
6.3.1	Default password	59
6.3.2	Advanced Settings	59
6.3.3	Web Based Management (WBM)	59
7	Accessories	62
<hr/>		
7.1	Headset	62
7.2	USB Wi-Fi adapter	62
7.3	Wall mount	63
8	Technical specifications	64
9	Ordering information	65
10	Guarantee and clauses	66
<hr/>		
10.1	Safety instructions	66

1 Getting to know your desk phone

1.1 Packaging list

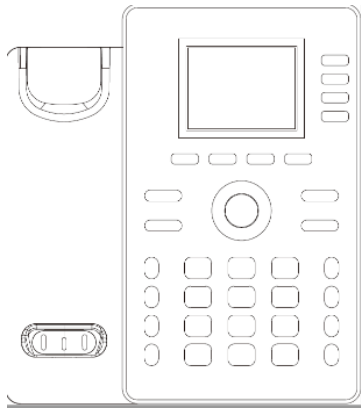

Desk phone



Handset

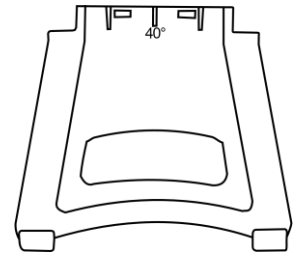

Phone stand



Handset cord



Ethernet cable

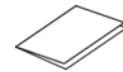

Safety manual and quick installation guide

1.2 Installing your desk phone

1.2.1 Installing the foot

You can use those three compartments on the back side to fix the phone. Depending on the way you insert the foot into the compartment, your desk phone will have a different angle:

A

B

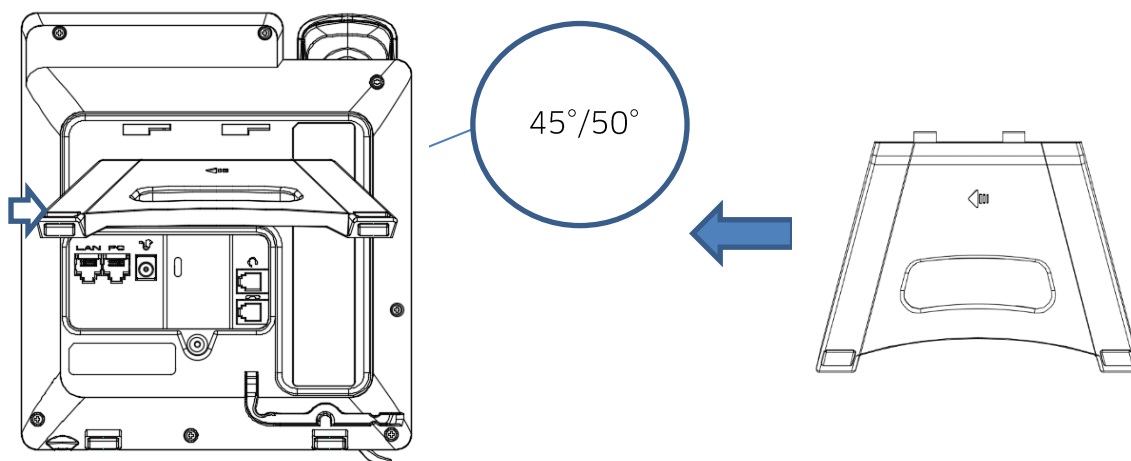

To mount the foot, push it to the right as the arrow indicates in the picture on the left.

To remove the foot, pull it to the left as the arrow indicates until it separates from the phone.

1.2.2 Connecting your desk phone

Please read safety instructions first (details chapter 10.1).

Firstly, connect the handset cord to the lower notch (4) if it is not correctly connected (your phone is usually provided with the handset cord connected).

If your desk phone is not correctly configured, you can connect it to the network (1) ((2) is used to connect to your PC). If your desk phone is not powered by PoE (Power over Ethernet), you have to connect the phone to the external power supply which supports DC JACK connector (3). For more information, contact your administrator.



1.2.3 Installing a wired handset

By default, your handset cord is correctly connected to the phone. If you have to replace it:

- Please refer to the previous section, then plug-in the wired handset to the appropriate connector.
- Make sure you position and fix the cord correctly in the compartment intended for that purpose.

2 Getting to know your telephone

2.1 H6 DeskPhone

H6 DeskPhone is part of the new Alcatel-Lucent Enterprise DeskPhones. With its color display associated to 4 dedicated function keys, and an intuitive navigation key, H6 DeskPhone delivers excellent user experience and optimum calling effect. H6 DeskPhone is compatible with remote working VPN. By this way, it is perfect for use at your office in your enterprise or at home (remote working).



1	2.8-inch color screen.	6	Navigation key.
2	12 virtual programmable keys (navigating through 4 pages) can be configured to various features including SIP accounts and speed dial. You can navigate through pages on the screen with the navigation key to use different programmable keys.	7	HD loudspeakers.
3	Soft keys: provide menu options and relevant features. Soft keys can be configured to different options by the administrator. <ul style="list-style-type: none"> In the Idle state: you can press soft keys to enter menus in different levels to operate and manage the phone. In the conversation mode: soft keys provide different actions depending on the application scenarios. 	8	HD wide-band wired handset.
4	Function keys: quick access to the phone's features.	9	2-degree foot (45°, 50°).
5	LED Information Light		

2.2 H3P/H3G DeskPhone

H3P/H3G DeskPhone is part of the new Alcatel-Lucent Enterprise Halo DeskPhones. H3P/H3G DeskPhone is provided with a backlight black-and-white display associated to 3 dedicated function keys, and an intuitive navigation key, H3P/H3G DeskPhone delivers excellent user experience and optimum calling effect. H3P/H3G DeskPhone is compatible with remote working. By this way, it is perfect for use at your office in your enterprise or at home (remote working). The difference between the sets is the port speed: H3P Deskphone supports Dual 100 Mbps Ethernet ports while H3G Deskphone supports Dual 1000 Mbps Ethernet ports.



1	2.8-inch black-and-white screen.	6	Navigation key.
2	8 virtual programmable keys (navigating through 4 pages) can be configured to various features including SIP accounts and speed dial. You can navigate through pages on the screen with the navigation key to use different keys.	7	HD loudspeakers.
3	Soft keys: provide menu options and relevant features. Soft keys can be configured to different options by the administrator. <ul style="list-style-type: none"> In the Idle state: you can press soft keys to enter menus in different levels to operate and manage the phone. In the conversation mode: soft keys provide different actions depending on the application scenarios. 	8	HD wide-band wired handset.
4	Function keys: quick access to the phone's features.	9	2-degree foot (45°, 50°).
5	LED Information Light		

2.3 Main screen

The main screen, composed of 4 pages, displays all the information about programmable keys, such as the registered SIP account and speed dial.



1	Press the Menu soft key to display submenus for various features and configuring or managing the phone. Use up-down navigation keys to navigate through the menu items. Press OK to perform the selected menu features.
2	3 dynamic keys are configurable by your administrator to access features of the phone depending on your needs.
3	Line keys are associated with SIP accounts (optional). Press the line key associated with a SIP account to make a call with this account or to answer an incoming call to this account.
4	Programmable keys. Press the programmable key to use features of the relevant settings, such as immediately making a call. Long press the programmable key to enter the programmable key configuration interface.
5	Virtual page navigation key Use the right-left navigation keys or the programmable key next to the '1234' icon to navigate through virtual pages. The number of the current page is highlighted.
6	Displays date, time and some status icons of the phone.

2.4 Call management interface



- 1 Features on the soft key labels depend on the call status. Press the relevant key to perform the action. For example, you can pause transfer the current call.
- 2 Displays SIP account in conversation.
- 3 Displays the incoming call and the corresponding conversation status, such as phone number and duration.

2.5 Navigation key

OK key:

Press OK key to validate the status of an option.

Left-right navigation keys:

When you input the text, use the keys to move the cursor, move the option or move from one page to another.

Up-down navigation keys:

Use to select an item on a list. When the information extends more than one page, use the down navigation key to display the next page. Use the up navigation key to display the previous page.

Use up-down navigation keys on a menu to browse the item or an option on the menu.



Back/Exit key:











Use C key to go back to the previous menu.



Bkspc Delete the last entered number or character.

More More options.

2.6 Permanent function keys

	<ul style="list-style-type: none"> • Answer an incoming call or make a call. • Short press to enter the list of last number dialed.
	<ul style="list-style-type: none"> • Place a call on hold. • Recover the call on hold.
	<ul style="list-style-type: none"> • Transfer a call.
	<ul style="list-style-type: none"> • Start a conference call with contacts and add participants to a conference call.
	<ul style="list-style-type: none"> • Reject an incoming call. • Hang up. • Return to the main screen.
	<ul style="list-style-type: none"> • Mute key During a call, press this key to stop your contact from hearing you. When activated, the key is lit red.
	<ul style="list-style-type: none"> • Voice mail The message key flashes when you have missed an incoming call or received a new voice mail. The key stays on if there are old messages in the voice mailbox.
	<ul style="list-style-type: none"> • Press this key to open dialer in handsfree mode. • Press this key to answer an incoming call in handsfree mode. • When a call is in progress, press this key to switch from handsfree mode to headset or handset mode.
	<ul style="list-style-type: none"> • Decrease the ringer volume in idle state or when you receive an incoming call. • Decrease the volume of the handset, loudspeaker or headset during a telephone call.
	<ul style="list-style-type: none"> • Increase the ringer volume in idle state or when you receive an incoming call. • Increase the volume of the handset, loudspeaker or headset during a telephone call.

2.7 Programmable key icons

This table lists icons displayed on the main screen when you program a key. To program a key, see the chapter: programmable keys.

	<ul style="list-style-type: none"> • SIP Accounts.
	<ul style="list-style-type: none"> • Speed dial.
	<ul style="list-style-type: none"> • BLF/ BLF list.
	<ul style="list-style-type: none"> • Hold.
	<ul style="list-style-type: none"> • Call Transfer.
	<ul style="list-style-type: none"> • Conference.
	<ul style="list-style-type: none"> • Redial the last number.
	<ul style="list-style-type: none"> • Do not disturb (DND).
	<ul style="list-style-type: none"> • Directory.
	<ul style="list-style-type: none"> • Forward.
	<ul style="list-style-type: none"> • Voice mail.
	<ul style="list-style-type: none"> • Hot Desking.
	<ul style="list-style-type: none"> • Prefix.
	<ul style="list-style-type: none"> • DTMF Tone.
	<ul style="list-style-type: none"> • Direct pick up.
	<ul style="list-style-type: none"> • Group pick up.
	<ul style="list-style-type: none"> • Headset.
	<ul style="list-style-type: none"> • Group Listen.
	<ul style="list-style-type: none"> • Intercom.
	<ul style="list-style-type: none"> • Audio Hub.
	<ul style="list-style-type: none"> • XML browser.
	<ul style="list-style-type: none"> • Phone Lock.







2.8 Telephone status/Call icons

Icons provide information under a certain status or the status of a specific call.

Status icons

Depending on the size of the display, all status icons may not be displayed simultaneously. Which icons are displayed depends on their priority. The following icons are listed according to their priority, from the highest to the lowest.

Status icons are displayed on the status bar at the top of the screen.

	Silent mode.
	Telephone locked.
	Headset connected.
	Handsfree connected.
	Wi-Fi enabled.
	Auto answer mode.
	Do not disturb (DND).
	Upgrading in progress in background.

Call icons

Call icons are associated with SIP accounts

	SIP Accounts (idle state).
	Incoming call icon.
	Call in progress icon.
	Call on hold icon.





2.9 Alpha-numeric dialpad

The phone is equipped with an alphanumeric dialpad. You can switch between numeric dialpad to dial number, and alphabetic dialpad to enter text by pressing the corresponding programmed key.

- Switch between the alphabetic and numeric modes:

<i>abc/ABC/Abc</i>	When in a text box, you can switch to the alphabetic dialpad by pressing "123".
<i>123</i>	When the alphabetic mode is activated, switch to the numeric mode by pressing "abc/ABC/Abc".

- Enter alphabetic characters
The numeric dialpad has letters that can be displayed by successively pressing. The number is the last character in the series. Some special characters can be displayed by successively pressing the key:

	% \$ / ~ & () [] = *
	@ #
	space - _ 1
	+ . , ; : / \ ? ! 0



- Use navigation keys to move the cursor into the text.
- Bkspc Delete the last entered character. The alphabetic mode remains activated.

2.10 Desk phone connectors

The phone supports multiple connectors, which you can use to extend the features of the phone.

The diagram for the connectors of H3P/H3G/H6 DeskPhone

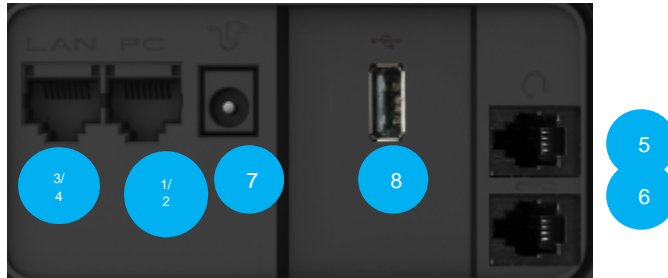

		H3P	H3G	H6
1	100/1000 Mbps Ethernet ports to the local area network (LAN - RJ45), and also support Power over Ethernet (PoE).	●		
2	100 Mbps Ethernet ports to a PC (RJ45).	●		
3	1000 Mbps Ethernet ports to the local area network (RJ45) and also support Power over Ethernet (PoE).		●	●
4	1000 Mbps Ethernet ports to a PC (RJ45).		●	●
5	Wired headset connector (RJ9).	●	●	●
6	Wired handset connector (RJ9).	●	●	●
7	External power supply	●	●	●
8	USB Type A connector. This connector can be used for: <ul style="list-style-type: none"> Connecting a USB headset. Connecting an external wireless module (Wi-Fi dongle*). 			●

* For more information about the external wireless module of the phone, please contact your administrator or relevant sales and service staff in Alcatel-Lucent Enterprise.

3 Using your telephone

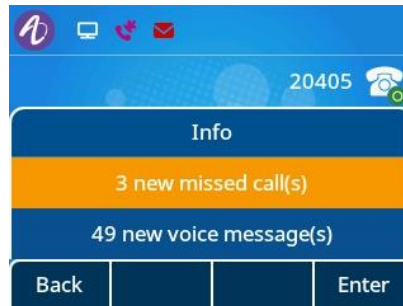

3.1 Information about the phone

The main screen can display all SIP accounts used on the phone and programmable keys.



Information about new events such as missed calls and new voice mail(s) are displayed in a pop-up on the main screen. The message key flashes red when you have received a new voice mail or missed an incoming call.

3.1.1 Information about the events

	Press the message key to display a new event pop-up.
	Enter with up-down navigation keys to view the event details.
 or <i>Enter</i>	



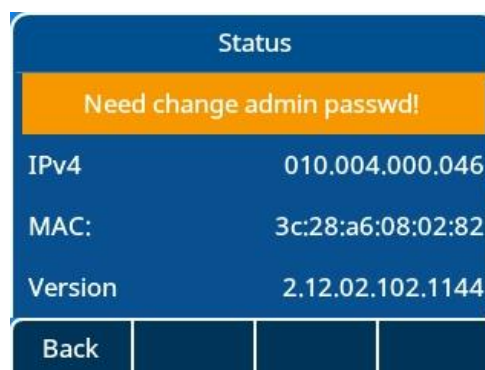

3.1.2 Information about the phone status

In idle screen, you can press OK key to get the phone's basic information, including the phone's IP address, MAC address, software version, etc. You can also use up-down navigation keys to select More for information about the phone's network and account.





3.2 Multiple SIP Accounts



H3 DeskPhone supports 3 SIP accounts, while H6 DeskPhone supports 4 SIP accounts. A default account will be used for calls unless you select the relevant account prior the call. It is recommended to program a key for each SIP account and put the key on the homepage. Then the status of the account will be displayed on the homepage. The key of the SIP account used to receive calls will flash. You can quickly answer the call to a certain account by pressing the programmable key. The descriptions to different account icons are as follows:

	If you configure an account key on the homepage, press it to select the corresponding account for making a call.
	The default SIP account is marked by a green point.
	Call forward is activated for this account.
	DND is activated for this account.
	The registration for this account failed.

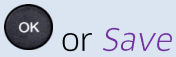
3.2.1 Configuring the programmable keys for an account

	Long press on a programmable key.
	Select the type of the programmable key: Account Select the relevant account. Add a label.
	Save the configuration for this programmable key.

3.2.2 Defining the default SIP Account





	The phone is in idle state.
<i>Menu</i>	Press the Menu key to enter the Main Menu.
<i>Features</i>	Use up-down navigation keys and OK key to select: <i>Features</i> .
<i>Default Account</i>	Use up-down navigation keys and OK key to select Default Account.
	Save an account as the default account.
	Validate your choice
	Complete the settings

3.3 Making a call

This section describes how to make a call. We provide different method to open the dialer before calling your contact.





3.3.1 Opening the dialer

Use one of the following methods:

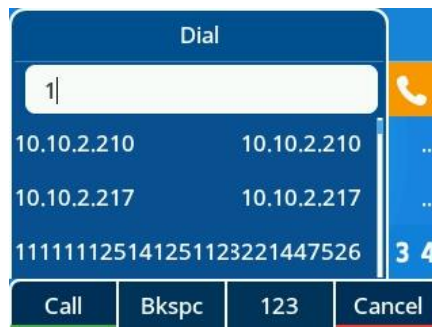
	Enter the number directly on the dialpad.
	Offhook the handset.
	Press the Dial key.
	Press the Handsfree key.
	If a programmable key for SIP account is set on the homepage, press the SIP account key to access the dialer.

3.3.2 Dialing the phone number



	Open the dialer
Use one of the following methods:	
	Enter the number
	Select the corresponding contact from the dial out list.
Use one of the following methods:	
	Press the Dial key. Make the call with the active device: handset if offhooked, headset if connected, otherwise in handsfree mode.
	Press the OK key to make a call.
Call	Press the Call key to make a call.
# or *	If defined in the phone settings, you can use these keys to initiate the call.

Depending on the system, after dialing the number, the call can be started automatically after a delay without action.





When you are in handsfree mode, you can take the call at any time on the handset by offhooking it. Or press the Headset key to switch the audio from handsfree to headset or from headset to handsfree.

To make an external call, dial the outside line access code before dialing your contact number. The call will start after a timeout of approx. 10 seconds if there is no action taken after dialing. If you are using multiple SIP accounts on your phone, you can choose an account to make the call.

3.3.3 Calling by name

You can call a contact by his/her name using the search feature in the company directory. This feature depends on the system configuration. If necessary, contact your administrator.



Use the alpha-numeric dialpad to switch between the numeric and alphabetic dialpad.

	Open the dialer.
<i>abc</i>	Switch to the alphabetical dialpad.
	Enter the first letter of your contact's name. The corresponding contacts will appear in a list. Entering more characters will narrow the search until the matched name is displayed.
	Use up-down navigation keys to select the contact you want to call.
Use one of the following:	
	Press the Dial key. Make the call with the active device: handset if unhooked, headset if connected, otherwise in handsfree mode.
	Press the OK key to make a call.
<i>Call</i>	Press the Call soft key to start the call.
# or *	If defined in the phone settings, you can use these keys to initiate the call.

3.3.4 Calling from the call log

You can call back a contact from the call log.

From the homepage or the dialer:





History	Select the soft key to open call logs.
	Use up-down navigation keys to select the contact you want to call.
Use one of the following:	
	Press the Dial key. Make the call with the active device: handset if unhooked, headset if connected, otherwise in handsfree mode.
	Press the OK key to make a call.
<i>Call</i>	Press the Call soft key to start the call.

If you are using multiple SIP accounts on your phone, the call back is made with the SIP account displayed in the call log.

3.3.5 Calling using your personal directory

You can unhook the handset or the headset to make a call with the handset or the headset, otherwise you make a call in handsfree mode.

From the homepage or the dialer:

Directory	Select the soft key to open your local directory from the homepage or the dialer.
	Select a directory.
	Select the contact to call.
Use one of the following:	
	Press the Dial key. Make the call with the active device: handset if unhooked, headset if connected, otherwise in handsfree mode.
	Press the OK key to make a call.
<i>Call</i>	Press the Call soft key to start the call.

If you are using multiple SIP accounts on your phone, you can choose which account to use to make the call.

3.3.6 Calling using Speed Dial key

You can pre-define the speed dial by long pressing the programmable key to the right of the LCD, entering the "Program Keys" setting page, choosing "Speed Dial" as Key Type, inputting the number to be called and account.



If you are using multiple SIP accounts on your phone, you must choose which account to use to make the call.

3.3.7 Making a peer to peer SIP call

The phone is compatible with the peer to peer IP call. It is able to call phones connected to the same local network. You can call your contact by entering the IP address of your contact's deskphone.





	Open the dialer. Enter the IP address of the peer end, such as 10*0*0*1, then dial out.
---	--

The format of the entered IP address must be x*x*x*x where x is a decimal value between 0 and 255.

This feature is useful when you have no connection to a communication server (no registration, network problems, etc.). Not all the features are available. Should this occur and the phone's status should be displayed on the screen. This feature can be deactivated by your administrator.

3.4 Receiving a call

When receiving a call, you can:

	Unhook the handset to take the call.
	Press the Headset key to activate the headset and take the call.
	Press the Loudspeaker/Handsfree key to take the call in handsfree mode.
	Press the blinking line key to take the call.
Take call or 	Take the call with the headset if connected, or in handsfree mode.
 or Reject call	Transfer the call to your voicemail.
Mute key	Mute the ringer (the call is still incoming but the phone no longer rings).
Transfer	Transfer the call to another number.

3.5 Switching between audio modes

During the conversation, you can switch between different audio modes (handset, handsfree or headset, if connected) by pressing the Loudspeaker/Handsfree key or Headset icon. This feature depends on connected devices.

- When you are in conversation using the handset, you can switch between handset and hand free by pressing the Handsfree key.



- When you are in conversation using the headset, you can switch between headset, handset and hand free by pressing the Handsfree or Headset key or unhooking the handset.

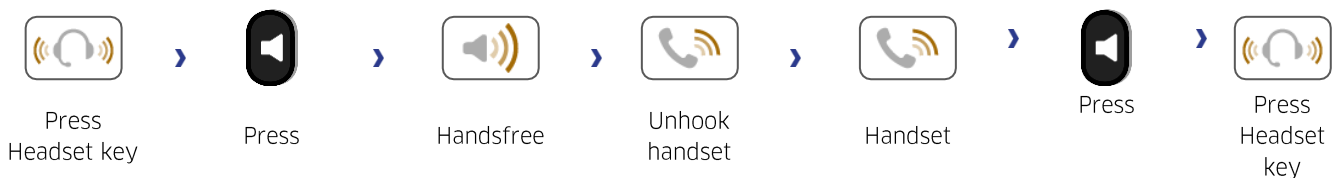

- You can pre-program the group listening key and press the programmable key during a call to activate the feature.

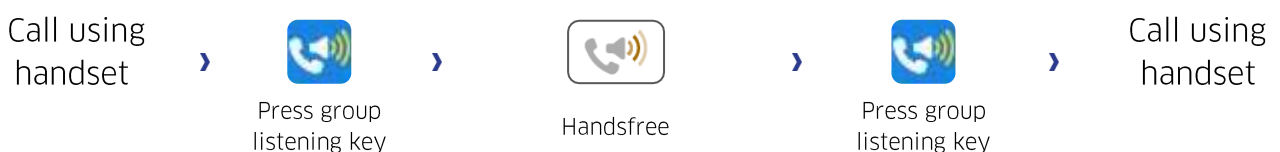

For each audio mode, during the conversation, you can adjust the volume by pressing the volume keys. The number of levels depends on the audio mode (8 for handset and headset, 10 for handsfree).

3.6 Redialing

3.6.1 Redial list



Short press to enter the redial list. The last dialed number is highlighted.

You can also press the Call key.

Press the OK key to display details.

3.7 Directory management

3.7.1 Contacts

A contact can be opened from your local directory.

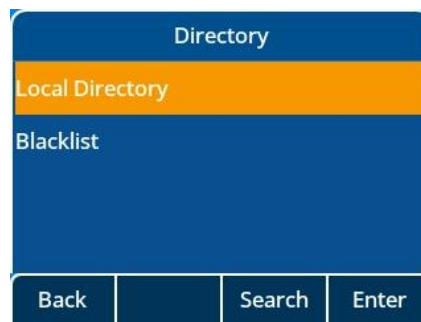

Directory

Select the soft key to open your directory.



Open a directory.



Select a contact.

More → Detail

Modify a contact.



Use up-down navigation keys to select items to be modified.

The contact card displays information about the contact.

- Avatar: Select a predefined image.
- Last name
- First name
- Office number
- Mobile
- Other
- Account: If you are using multiple SIP accounts, define an account to use to call the contact.
- Group: Define the group to which this contact belongs.

3.7.2 Contacts management

Your desk phone allows you to manage contacts in your local directory.

How to manage contacts in the directory:

Use one of the following:

<i>Directory</i>	Select the directory on the soft key.
<i>Menu → Directory</i>	Use the menu to access your directory.

Categories of directory:

<i>Directory</i>	Use the menu or soft key to access your directory.
<i>Local Directory</i>	Your local directory stores all saved contacts and groups.
<i>External Directory</i>	External directory is not supported by H3P, H3G, and H6.



Operations on contacts in the directory:

<i>Search</i>	Search a contact.
<i>Add</i>	Create a new contact.
<i>Bkspc</i>	Delete a contact.
<i>More</i>	Display more.
<i>Call</i>	Call the selected contact.
<i>Detail</i>	Display information about a contact.
<i>Delete all</i>	Delete all contacts or groups.
<i>AddGrp</i>	Add a new group.
<i>Enter</i>	Confirm the selected items.
<i>Back</i>	Return to the previous menu or main page.



3.7.3 Calling your contact

<i>Directory</i>	Select the soft key to open your directory.
------------------	---

Use one of the following methods:

<i>Search</i>	Search for contacts in all directories and groups.
	Select the searched contacts.
	Select the number you want to call.
 or Call	Start the call.

3.7.4 Creating a new contact

<i>Directory</i>	Select the soft key to open your directory.
<i>Local Directory</i>	Open the local directory.
Add	Press the soft key to create a new contact.
Switch or 	<ul style="list-style-type: none"> Avatar: Select a predefined image. Account: If you are using multiple SIP accounts, define an account to use to call the contact. Group: Define the group to which this contact belongs.
<Abc>	<ul style="list-style-type: none"> Last name First name
<123>	<ul style="list-style-type: none"> Office number Mobile Other
 or Save	The new contact is added to the local directory.

Other method:



- Add a contact from the call log.

For external numbers, we recommend you use a canonical address format comprising '+', followed by the country code (e.g. '33'), and then the number without the first digit. For example, for 00390670000, enter the number +3390670000. To get the '+' sign, long press on the '0' key. This example is for calling a number in France from another country.



3.7.5 Creating a new group

<i>Directory</i>	Select the soft key to open your directory.
<i>Local Directory</i>	Open the local directory.
<i>AddGrp</i>	Select to add a group.
<Abc><123>	Enter the name of the group.
 or Save	The new group is added to the directory.



3.7.6 Modifying a contact

<i>Directory</i>	Select the soft key to open your directory.
<i>Local Directory</i>	Open the local directory.
	Select the contact to modify.
<i>More</i>	Access more features.
<i>Detail</i>	
	Fill in the contact information. Use up-down navigation keys to edit a field.
 or Save	Save the contact in the local directory.



3.7.7 Delete a contact.

<i>Directory</i>	Select the soft key to open your directory.
	Select the soft key to access your directory.
	Use up-down navigation keys to select the contact to delete.
<i>Bkspc</i>	Press the soft key.
 or <i>OK</i>	Confirm the deletion.



3.7.8 Deleting all contacts

<i>Directory</i>	Select the soft key to open your directory.
<i>Local Directory</i>	Open the local directory.
	Use up-down navigation keys to select the contact to be deleted.
<i>More</i>	Press the soft key.
<i>Delete all</i>	
 or <i>OK</i>	Confirm the deletion.

3.7.9 Deleting a group in the local directory

<i>Directory</i>	Select the soft key to open your directory.
<i>Local Directory</i>	Open the local directory.
<i>Group</i>	Access a group.
	Select the group to delete.
<i>Bkspc</i>	Press to delete a group.
 or <i>OK</i>	Confirm the deletion.

3.7.10 Deleting all groups in the local directory

<i>Directory</i>	Select the soft key to open your directory.
<i>Group</i>	Access a group.
	Select the group to be deleted.
<i>Delete all</i>	Press to delete a group.
 or <i>OK</i>	Confirm the deletion.

3.8 Managing the call log (history)

The call log can be queried and managed when the phone is in the idle state.

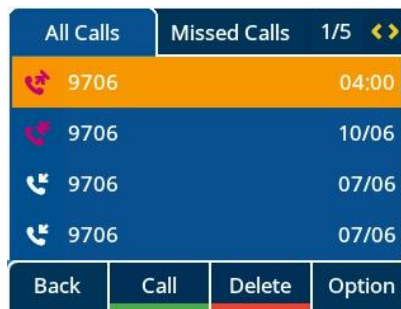





The call log is accessible from the dynamic programmable key on the phone homepage or by the menu.

Use one of the following methods:

<i>History</i>	If configured, use the History dynamic programmable key to access to the call log directory.
<i>Menu → History</i>	Use the Menu key to access the call log.

In this user manual, we use the dynamic programmable key to access the call log.



All call logs are displayed with an icon showing the type of call.

	Answered incoming calls.
	Missed calls.
	Unanswered incoming call that has been acknowledged.
	Answered outgoing calls.
	Unanswered outgoing calls.

Actions available from the call log:

<i>Bkspc</i>	Delete the selected entry. Note that no confirmation is requested.
<i>Call</i>	Call the selected entry.
<i>More</i>	Access more features.
 or <i>Detail</i>	View details about the selected entry: name, number, time, relevant SIP account, and duration.
<i>Delete all</i>	Delete the entire log associated with the selected contact. Note that no confirmation is requested.
<i>Missed</i>	Display missed calls only.
<i>AddClist</i>	Add the selected contact in your local directory. If the contact already exists, the screen for editing the contact is displayed.
<i>Back</i>	Go back to the Homepage.

3.8.1 Calling a contact

<i>History</i>	Select the soft key to open call logs from the homepage or the dialer.
	Select the contact to call.
Use one of the following methods:	
	Press the Call key to make a call with the active device: handset if unhooked, headset if connected, otherwise in handsfree mode.
	Press the OK key to make a call with the active device: handset if unhooked, headset if connected, otherwise in handsfree mode.
<i>Call</i>	Press the Call key to make a call with the active device: handset if unhooked, headset if connected, otherwise in handsfree mode.

3.8.2 Displaying missed calls only

<i>History</i>	Select the soft key to open call logs from the homepage or the dialer.
<i>Missed</i>	Press this key to display missed calls only.

3.8.3 Deleting the call log of a contact

<i>History</i>	Select the soft key to open call logs from the homepage or the dialer.
	Select the contact log to delete.
<i>Bkspc</i>	Delete the selected call log. Note that no confirmation is requested.

3.8.4 Clearing the call log

<i>History</i>	Select the soft key to open call logs from the homepage or the dialer.
<i>More</i>	Access more features.
<i>Delete all</i>	
 or <i>OK</i>	Confirm the deletion.



If you are using multiple SIP accounts on your phone, the concerned SIP account is displayed in entry details of the call log ( or *Detail*).

3.9 Managing speed dial

Speed dial allows you to call a number rapidly. You can create Speed Dial keys by programming keys from the homepage.

3.9.1 Creating a Speed Dial key

Use one of the following methods:

	Long press on a free programmable key.
<p><i>Menu -> Features -> Program Keys</i></p>	Use up-down and "OK" navigation keys to select: <i>Program Keys</i> .
Creating a Speed Dial key	
<p><i>Switch</i> or </p> <p><i>Account</i></p> <p><i><123><Abc></i></p> <p> or <i>Save</i></p>	<p>Define the type of programmable key: <i>Speed dial</i>.</p> <p>Associate a SIP account for making a call.</p> <p>Enter the number and its label.</p> <p>Save the Speed Dial key.</p>

3.9.2 Making a call using speed dial

	 Select the Speed Dial key for making a call.
---	--



3.10 Sending DTMF signals

During a conversation, you may have to send DTMF signals, for example, with a voice server, an automated attendant or a remotely consulted answering machine.

	Enter DTMF code.
---	------------------

- To activate or deactivate DTMF mode





The phone is in idle state:

<p><i>Menu</i></p>	Press the Menu soft key to access the Main Menu.
<p><i>Basic Settings</i></p>	Use up-down and "OK" navigation keys to select: <i>Basic Setting</i> .
<p><i>Sound</i></p>	Use up-down and "OK" navigation keys to select: <i>Sound</i> .
<p><i>DTMF Tone</i></p>	Use up-down and "OK" navigation keys to select: <i>DTMF Tone</i> .
<p><i>Switch</i> or </p>	To activate or deactivate DTMF mode
<p> or <i>Save</i></p>	Validate your choice
	End the settings.

3.11 Muting the microphone, so that your contact cannot hear you

You can hear your contact but he/she cannot hear you.

During a conversation:





	Disable the microphone. >>  The key lights up.
	Resume the conversation. >>  The key is no longer lit.

3.12 Auto answer

In the auto answer mode, calls are automatically answered.

To enable the auto answer:

The phone is in idle state:

<i>Menu</i>	Press the Menu soft key to access the Main Menu.
<i>Features</i>	Use up-down and "OK" navigation keys to select: <i>Features</i> .
<i>Auto answer</i>	Use up-down and "OK" navigation keys to select: <i>Auto answer</i> .
	Select the SIP account. All incoming calls to this SIP account will be automatically answered.
<i>Switch</i> or 	Enable the auto answer.
 or <i>Save</i>	Save the setting.
	This icon is displayed in the status bar.

3.13 Making an intercom call

When you make an intercom call, the call is automatically picked-up by your contact if intercom is enabled on your contact's phone. The ring tone will then be different.



To make an intercom call, you have to create a programmable key: *Intercom*.

- *Account*: Select the relevant SIP account.
- *Label*: Enter the label of the key displayed on the homepage.
- *Value*: Enter the contact number to call.

3.14 Configuring intercom calls

When you receive an intercom call, the desk phone automatically answers the call if you have enabled this feature. You can manage actions to be taken by your desk phone when you receive an intercom call.

The phone is in idle state:





<i>Menu</i>	Press the Menu soft key to access the Main Menu.
<i>Features</i>	Use up-down and "OK" navigation keys to select: <i>Features</i> .
<i>Intercom</i>	Use up-down and "OK" navigation keys to select: <i>Intercom</i> .
	Select the SIP account. All incoming calls to this SIP account will be automatically answered.
<i>Switch</i> or 	<ul style="list-style-type: none"> <i>Allow</i>: Enable/Disable intercom call. <i>Mute</i>: Enable/Disable mute. <i>Tone</i>: Enable/Disable tone. <i>Barge</i>: Enable/disable barge.
 or <i>Save</i>	Save the setting.

3.15 Changing a PIN code

The PIN code is required to unlock the phone.

The default PIN code is 0000.



The phone is in idle state:

<i>Menu</i>	Press the Menu soft key to access the Main Menu.
<i>Basic Settings</i>	Use up-down and "OK" navigation keys to select: <i>Basic Setting</i> .
<i>Changing a PIN code</i>	Use up-down and "OK" navigation keys to select: <i>Changing a PIN code</i>
	Enter the current PIN code.
	Enter the new PIN code
	Confirm the new PIN code
 or <i>Save</i>	Save the setting.
	End the settings.

3.16 Locking/Unlocking your desk phone

Enable the phone lock.



The phone is in idle state:

<i>Menu</i>	Press the Menu soft key to access the Main Menu.
<i>Basic Settings</i>	Use up-down and "OK" navigation keys to select: <i>Basic Setting</i> .
<i>Phone Lock</i>	Use up-down and "OK" navigation keys to select: <i>Phone Lock</i>
<i>Switch</i> or  	Enable the option: <i>Lock Enable</i>
	End the settings.

To lock/unlock your desk phone, you can also create a programmable key: *Phone Lock*.

- o *Label*: Enter the label of the key displayed on the homepage.

3.16.1 Locking your desk phone

	Select the lock/unlock programmable key.
<i>OK</i> / 	Validate your choice Your phone is locked.





You can only call emergency numbers once the phone is locked (up to 3 numbers, configured by the administrator).

3.16.2 Unlocking your desk phone

	Unlock your desk phone. A PIN code is required to unlock the desk phone (the default PIN code is 0000).
---	---

3.16.3 Activating or deactivating the automatic keypad lock

The phone is in idle state:

<i>Menu</i>	Press the Menu soft key to access the Main Menu.
<i>Basic Settings</i>	Use up-down and "OK" navigation keys to select: <i>Basic Setting</i> .
<i>Phone Lock</i>	Use up-down and "OK" navigation keys to select: <i>Phone Lock</i>
<i>Switch</i> or 	Enable the option: <i>Auto Lock Enable</i> .
	Enter the timeout without activity before the keylock (seconds).
 or <i>Save</i>	Validate your choice
	End the settings.

3.17 During a conversation

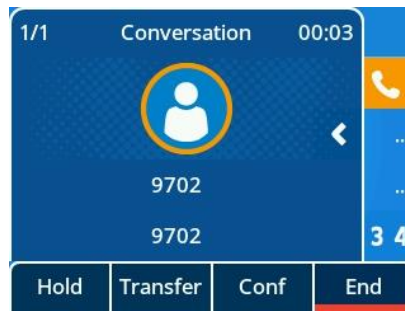

Actions available during a conversation:





<i>End</i>	End the call.
<i>Hold</i>	Place the call on hold.
<i>Transfer</i>	Transfer the call.
<i>Resume</i>	Resume a call (on hold, muted).
<i>New</i>	Make a second call when the first call is on hold.
<i>Swap</i>	Switch between calls.
<i>Conf</i>	Establish a conference call.
<i>End conf</i>	End the conference with all participants.

3.18 Making a second call during a conversation

During a conversation:

<i>Hold</i>	Your first call is placed on hold.
<i>New</i>	The dialer and call log are displayed.





Use one of the following methods:

	Enter the number
	Select a contact in the call log.
<i>Directory</i> →  or <i>Call</i>	Select a contact from the local directory.
<Abc> →  or <i>Call</i>	Call your contact using the Dial By Name feature.
	Select the Redial feature.

3.19 Answering a second call during a conversation

During a conversation, another person is trying to call you. You are alerted with 3 beeps. The information about the second call is displayed on the screen. The key of the SIP account is blinking blue.

Use one of the following methods:

	Press the blinking line key associated with the SIP account receiving the call.
<i>Take call</i> or 	Take the call with the headset if connected, or in handsfree mode.
 or <i>Reject call</i>	Deflect the call to your voicemail.
<i>Mute key</i>	Mute the ringing (the call is still incoming but the phone no longer rings).
<i>Forward</i>	Transfer the call to another contact. Use one of the following: <ul style="list-style-type: none"> ○ Use the up-down navigator (if necessary) to find the contact to call. ○ Enter the number or name of the contact to whom the call will be transferred.  Transfer the call to the selected contact.

If the second call comes in again, you can still forward it.

3.20 Canceling your second call and resuming the first call

You are in conversation with the second contact and the first contact is on hold.

Use one of the following methods:

	You or the second contact hangs up.
<i>End</i>	Press the soft key with the following label: <i>End</i> .
Resume the call on hold:	
<i>Resume</i>	Press the soft key with the following label: <i>Resume</i> . The call with your first contact is resumed.

3.21 Placing a call on hold

During a conversation, you wish to place the call on hold and resume it later on the same phone.



Place the call on hold:

Use one of the following methods:

	Press the Hold key.
<i>Hold</i>	Press the soft key with the following label: <i>Hold</i> .

Resume the call which is on hold.



Use one of the following methods:

	Press the Hold key.
<i>Resume</i>	Press the soft key with the following label: <i>Resume</i>
	Press the account key that is defined as hold.

3.22 Switching between calls

During a conversation, a second call is on hold.

Use one of the following methods:

<i>Swap</i>	Press the soft key with the following label: <i>Swap</i> .
	Press the Hold key.
	Press the account key that is defined as hold.

» You can talk to the first contact and the second contact is on hold.

3.23 Transferring a call

3.23.1 Transferring a call to another contact on hold

During a conversation, a second call is on hold.

Use one of the following methods:

	Press the Transfer key. » The two contacts are connected.
<i>Transfer</i>	Press the soft key with the following label: <i>Transfer</i> The two contacts are connected.

3.23.2 Transferring your call to another contact

During a conversation:

Use one of the following methods:

	Press the Transfer key. » The current call is on hold.
<i>Transfer</i>	Press the soft key with the following label: <i>Transfer</i> » The first call is on hold.

<i>New-></i>  or <i>Call</i>	Call a new contact by using the dialer and dialing by name from the call log or directory. Your contact answers the call.
---	--

Use one of the following methods:

	Press the Transfer key. » The two contacts are connected.
<i>Transfer</i>	Press the soft key with the following label: <i>Transfer</i> » The two contacts are connected.



Transfer between two external calls depends on the regulations of countries concerned and the server configuration.

3.23.3 Blind transfer

You can also immediately transfer your call, without having to wait for your contact to answer.

During a conversation:

Use one of the following methods:

	Press the Transfer key. » The current call is on hold.
<i>Transfer</i>	Press the soft key with the following label: <i>Transfer</i> » The first call is on hold.
<i>New -></i>  or <i>Call</i>	Call a new contact by using the dialer and dialing by name from the call log or directory.
<i>Blind transfer</i>	Before your contact answers the call, select B transf. » The two contacts are connected.

Transfer between two external calls depends on the regulations of countries concerned and the server configuration.

3.24 Three-party conference

During a conversation, a second call is on hold.

Use one of the following methods:

	Press the Conf key. » You are in conference mode.
<i>Conf</i>	Press the soft key with the following label: <i>Conf</i> » You are in conference mode.

3.24.1 End conf

You are in conference mode.

Use one of the following:

	Press the On-Hook key. » The conference is ended.
<i>End</i>	Press the soft key with the following label: <i>End conf</i> » The conference is ended.

3.24.2 Leaving your two contacts talking together after the conference

You are in conference mode.



Use one of the following:

	Press the Transfer key. » The two participants remain on the call.
<i>Transfer</i>	Press the soft key with the following label: <i>Transfer</i> » The two participants remain on the call.

3.25 Five-party conference

You are in a three-party conference call.

Use one of the following methods:

	Press the Hold key.
<i>Hold</i>	Press the soft key with the following label: <i>Hold</i> .
<i>New-></i>  or <i>Call</i>	Call a new participant by using the dialer and dialing by name from the call log or directory. You are in conversation with the new participant.
<i>Join</i>	The new participant is joining the conference call.

When the maximum of participants is reached, you will not be able to make a new call to add a new participant.

3.25.1 End conf

You are in conference mode.





Use one of the following methods:

	Press the On-Hook key. » The conference is ended.
<i>End conf</i>	Press the soft key with the following label: <i>End conf</i> » The conference is ended.

If you are a participant (you did not initiate the conference call), you can exit the conference by pressing the On-Hook key.





3.26 Hiding your phone number

You can choose to hide your identity when making a call.

	The phone is in idle state:
<i>Menu</i>	Press the Menu soft key to access the Main Menu.
<i>Features</i>	Use up-down and "OK" navigation keys to select: <i>Features</i> .
<i>Anonymous</i>	Use up-down and "OK" navigation keys to select: <i>Anonymous</i>
	Select the SIP account whose phone number will be hidden.
Switch or 	Enable the Anonymous option, and enter the relevant server-supported feature code.
 or <i>Save</i>	Validate your choice
	End the settings.

3.27 Rejecting anonymous calls



The phone is in idle state:

<i>Menu</i>	Press the Menu soft key to access the Main Menu.
<i>Features</i>	Use up-down and "OK" navigation keys to select: <i>Features</i> .
<i>Anonymous rejection</i>	Use up-down and "OK" navigation keys to select: <i>Anonymous rejection</i> .
	Select the corresponding SIP account.
Switch or 	Enable the option: <i>Anonymous rejection</i> , and enter the relevant server-supported feature code.
 or <i>Save</i>	Validate your choice
	End the settings.

3.28 Do not disturb (DND)

You can make your phone temporarily unavailable for all calls.

The phone is in idle state:

<i>Menu</i>	Press the Menu soft key to access the Main Menu.
<i>Features</i>	Use up-down and "OK" navigation keys to select: <i>Features</i> .
<i>DND</i>	Use up-down and "OK" navigation keys to select: <i>DND</i> .
Switch or 	Enable the DND option.
 or <i>Save</i>	Validate your choice
	End the settings.



To disable the DND feature, follow the same procedure. You can also program a key on the homepage to have a direct access to this feature.

3.29 Call Forward

When you are absent or already in a call, you can forward all your calls to a defined number. You can program a key to activate the Call Forward feature.



The phone is in idle state:

<i>Menu</i>	Press the Menu soft key to access the Main Menu.
<i>Features</i>	Use up-down and "OK" navigation keys to select: <i>Features</i> .
<i>Call Forward</i>	Use up-down and "OK" navigation keys to select: Call Forward.
Select the type of call forwarding	
<i>Always Forward</i>	All your calls are immediately forwarded to a defined number.
<i>Busy Forward</i>	All your calls are forwarded to a defined number when you are already on the line.
<i>No Answer Forward</i>	All your calls are forwarded to a defined number when you are unable to answer.

Switch or 	Enable the Call Forward feature.
<i>Transfer</i>	Enter the number.
 or Save	Validate your choice
	End the settings.

3.30 Canceling call forwarding



The phone is in idle state:

<i>Menu</i>	Press the Menu soft key to access the Main Menu.
<i>Features</i>	Use up-down and "OK" navigation keys to select: <i>Features</i> .
<i>Call Forward</i>	Use up-down and "OK" navigation keys to select: Call Forward.
Select the type of call forwarding to cancel	
<i>Always Forward</i>	All your calls are immediately forwarded to a defined number.
<i>Busy Forward</i>	All your calls are forwarded to a defined number when you are already on the line.
<i>No Answer Forward</i>	All your calls are forwarded to a defined number when you are unable to answer.
Switch or 	Disable the Call Forward feature.
 or Save	Validate your choice
	End the settings.

3.31 Listening to your voice messages

This feature depends on the PBX configuration. If necessary, contact your system administrator.



The message key flashes when you have received a new voice message or if you have missed calls.

	Press the message key. The number of voice messages received or calls missed is displayed on the screen.
<i>X new voice message(s)</i>	Use up-down and "OK" navigation keys to access voicemail.
	The number of new voice messages is displayed for each registered account. Select the relevant account.
 or <i>Enter</i>	Call your voicemail. Follow the voice guidance to listen to your voice messages from the voicemail server.

You can use the menu to access voicemail: *Menu* → *Voicemail* → *View Voice Messages*.

3.32 Defining a hotline number

If configured, the hotline number is dialed immediately or after a defined time delay when you pick up the handset or press the handsfree button or the Call button of the headset. Refer to the following requirements to configure a hotline number:

The phone is in idle state:	
Menu	Press the Menu soft key to access the Main Menu.
<i>Features</i>	Use up-down and "OK" navigation keys to select: <i>Features</i> .
<i>Hotline</i>	Use up-down and "OK" navigation keys to select: <i>Hotline</i> .
<i>Number</i>	Enter a hotline number.
<i>Delay</i>	Enter the time delay in seconds before the hotline number is dialed. The hotline number is immediately dialed if the delay is not configured.
Switch or 	Enable the Hotline feature
 or Save	Validate your choice
	End the settings.

Follow the same procedure to deactivate the Hotline feature. This feature can also be configured on the Web Based Management page.

4 Doing more with your desk phone

Your desk phone is designed to evolve with the environment. It can do more than just establishing communication between people or helping you keep in touch with your contacts and enterprises.

This chapter describes some use cases with your desk phone.

4.1 Configuring your desk phone for remote working

Your IP phone can be used for remote working (VPN) via a secure connection (encrypted). A Virtual Private Network (VPN) is a technology that allows a device to create a tunneling connection to a server and become part of the enterprise's network (VPN server's network). VPN tunnels are secured via the phone OpenVPN client with TLS authentication, credentials, and certificates.

To establish a VPN connection, make sure you have the following connection information from the host provider:

- Connection settings: server address, port, and protocol.
- CA root certification file (.crt).
- Client certification file (.crt).
- Client key file (.key).

The VPN connection must be configured, enabled, and disabled on the Web Based Management page.

- Open the Web Based Management page.
When the desk phone is connected to the network, your administrator can access the Web Based Management page via a web browser by entering the IP address of your desk phone. The administrator password of the phone is requested.

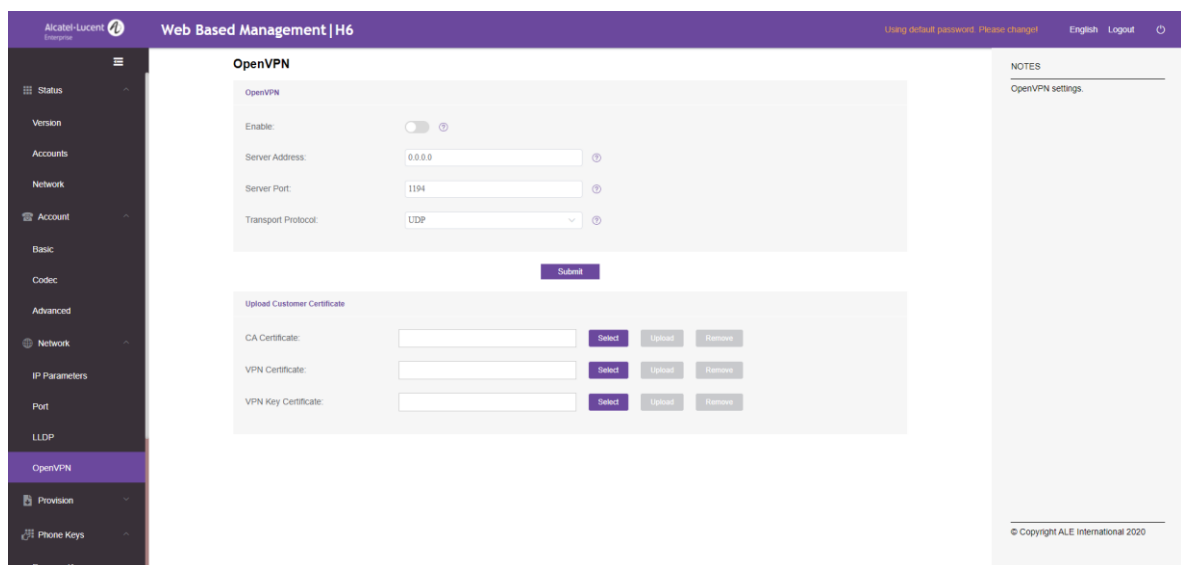

- In the left-side navigation pane, select OpenVPN.
- On the OpenVPN page, enter the required information (VPN server address, port, and protocol).

- Upload security files: click the Select button to select security files (CA root certification file, client certification file, and client key file) and then click the Upload button to upload them.
- Enable VPN.
- Click Submit.
- The desk phone restarts.

The connection will be established every time the system reboots until you manually disable the VPN.

Disable VPN:

- Open the Web Based Management page.
- In the left-side navigation pane, select OpenVPN.
- Disable VPN.
- Click Submit.
- The desk phone restarts.

4.2 Connecting your H6 DeskPhone to the Wi-Fi

You can connect your desk phone to the wireless network of your company or at your home. You must plug a USB wireless network card into the USB-A connector of your H6 DeskPhone: To know the supported card types, please refer to the Alcatel-Lucent Enterprise website or contact your administrator. The wireless network card can use 2.4 GHz and 5 GHz bands, but we recommend using a 5 GHz Wi-Fi network to ensure the best audio quality. The network with the best radio signal will be automatically selected by the desk phone. A specific icon is displayed in the status bar when your desk phone is connected to a Wi-Fi access point: .

4.2.1 Configuring the wireless network

You can manually configure your desk phone to connect it to a selected Wi-Fi access point (SSID). This section is useful when you connect your desk phone to your personal Wi-Fi network for remote working or to check the Wi-Fi configuration of the phone. Before configuring your phone, you need to know the name and the network security key (passphrase) of the Wi-Fi access point.

Plug the Wi-Fi adapter into the USB-A connector of the desk phone.

Start your desk phone (powered by PoE or adapter).









The phone is in idle state

Menu

Press the Menu soft key to access the Main Menu.

Advanced Settings

Use up-down and “OK” navigation keys to select: Advanced Settings. The administrator password of the phone is requested (the default password is 123456).

<i>Wi-Fi</i>	<p>All scanned SSIDs are listed in sequence according to the signal strength (it may take a few seconds to display the available networks). Use the up-down navigation keys to scroll the page.</p> <p>: this icon, displayed at the left of the SSID name, represents the signal strength. The more waves, the better the signal. During connection establishment, this icon is displayed at the right of the SSID name.</p> <p>: this icon indicates the current connected SSIDs.</p> <p>: this icon indicates SSIDs already saved in the desk phone.</p>
 or <i>Detail</i>	Display all information about the corresponding wireless network, such as the SSID, encryption mode, channel, and signal strength.
<i>Connect</i>	Connect the desk phone to the selected wireless network.
	<p>If the wireless network is not saved, enter the network security key (passphrase) if requested. Use the dialpad key to switch between the numeric and alphabetic dialpads.</p> <p>: during connection establishment, this icon is displayed (1 to 4 waves).</p>
	<p>If the connection is successful, a pop-up window is displayed on your phone.</p> <p>A specific icon is displayed in the status bar when your desk phone is connected to a Wi-Fi access point: . The SSID and password are automatically saved, if they have not been saved before.</p>

To switch back to a wired network, unplug the USB wireless network adapter, connect the network cable, and restart the desk phone.

4.2.2 Managing wireless networks

The Wi-Fi Manager allows you to manage all saved wireless network configurations on your desk phone. If a wireless network is available and saved on your desk phone, the desk phone automatically connects to the network. If there are several networks available, the network with the best signal will be selected.

4.2.2.1 Opening the Wi-Fi Manager

The phone is in idle state	
<i>Menu</i>	Press the Menu soft key to access the Main Menu.
<i>Advanced Settings</i>	Use up-down and "OK" navigation keys to select: Advanced Settings. The administrator password of the phone is requested. Confirm.
<i>Wi-Fi</i>	Use up-down and "OK" navigation keys to select: Wi-Fi Manager .

1. In the Wi-Fi menu, use up-down navigation keys to move the cursor and view the wireless network list.

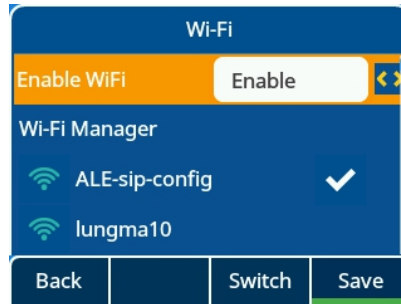

2. When the cursor moves to a wireless network, press the **Detail** key to view the detailed information about the network, including the SSID, encryption mode, and signaling channel.

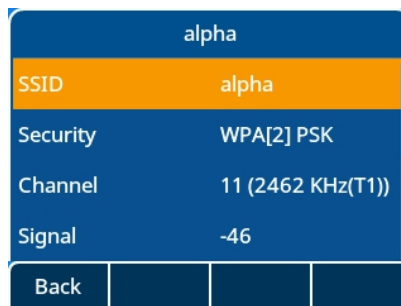



4.2.2.2 Adding a wireless network

Open the Wi-Fi Manager

<i>Add</i>	Enter the SSID, security mode, encryption mode, and password of a new wireless network. Use the dialpad key to switch between the numeric and alphabetic dialpads.
<i>Security</i>	Select a wireless encryption mode and enter the defined password.
<i>Save</i>	Save the wireless network.

4.2.2.3 Modifying a saved wireless network

Open the Wi-Fi Manager

	Use up-down navigation keys to select a saved wireless network to edit.
 or <i>Edit</i>	Modify the SSID, security mode, encryption mode, and password of the wireless network. Use the dialpad key to switch between the numeric and alphabetic dialpads.
<i>Save</i>	Save the wireless network.

4.2.2.4 Removing a saved wireless network

Open the Wi-Fi Manager

	Use up-down navigation keys to select a saved wireless network to delete.
<i>Bkspc</i>	Delete the selected wireless network.

4.3 Hot Desking

This feature allows you to use any compatible SIP desk phones in your company with your own phone number. When you activate your account on a desk phone, your entire phone configuration will be retrieved: local directory, history (requiring server support). After reboot, the phone restores its initial configuration.



We recommend activating only one phone number at a time to ensure that all incoming calls are received on the same phone.

This feature must be activated by the administrator of the desk phone.

Before using this feature, you must program a key on the desk phone for the feature: *Hot Desking*.

4.3.1 Log on to Hot Desking

When you start the Hot Desking feature, all user configurations on the desk phone are cleared.

	Select the Hot Desking programmed key.
OK	Confirm that all current user configurations will be cleared.
	Enter the phone number and password of your SIP account.
OK or Save	Confirm. The desk phone automatically loads the SIP account configuration. You can use the desk phone with your own account.

4.3.2 Log off from Hot Desking

When you want to leave the office and restore the initial state of the desk phone, you have to logout and reboot the phone.



5 Customizing your desk phone

5.1 Adjusting the audio features

The features described in this section can also be configured on the Web Based Management page.

5.1.1 Selecting the ringing

When the desk phone is in idle state:

<i>Menu</i>	Press the Menu soft key to access the Main Menu.
<i>Basic Settings</i>	Use up-down and "OK" navigation keys to select: <i>Basic Setting</i> .
<i>Sound</i>	Use up-down and "OK" navigation keys to select: <i>Sound</i> .
<i>Ringing</i>	Use up-down and "OK" navigation keys to select: <i>Ringing</i> .
<i>Int Melody/ Ext Melody</i>	Select the melodies for external and internal calls: <i>Int Melody/Ext Melody</i> .
	Select your melody (16 embedded melodies in total).
 or <i>Enter</i>	Validate your choice.
	End the procedure.





5.1.2 Adjusting the ringing volume

When the desk phone is in idle state:

	Select the volume you want (10 levels in total).
---	--



5.1.3 Configuring the ring mode

When the desk phone is in idle state:

<i>Menu</i>	Press the Menu soft key to access the Main Menu.
<i>Basic Settings</i>	Use up-down and "OK" navigation keys to select: <i>Basic Setting</i> .
<i>Sound</i>	Use up-down and "OK" navigation keys to select: <i>Sound</i> .
<i>Ringing</i>	Use up-down and "OK" navigation keys to select: <i>Ringing</i> .
<i>Ring mode</i>	Use up-down and "OK" navigation keys to select: <i>Ring mode</i> .
<i>Switch</i> or 	<ul style="list-style-type: none"> <i>Normal ringing</i> A normal ring signals an incoming call. <i>Progressive ringing</i> A progressive ring signals an incoming call.
<i>Switch</i> or 	<p>Enable or disable the silent mode: <i>Silent mode</i>.</p> <p>The desk phone no longer rings, but the LED flashes continuously to signal an incoming call.</p>
 or <i>Save</i>	Validate your choice.
	End the procedure.

5.1.4 Configuring the beep mode

When the desk phone is in idle state:



<i>Menu</i>	Press the Menu soft key to access the Main Menu.
<i>Basic Settings</i>	Use up-down and "OK" navigation keys to select: <i>Basic Setting</i> .
<i>Sound</i>	Use up-down and "OK" navigation keys to select: <i>Sound</i> .
<i>Ringing</i>	Use up-down and "OK" navigation keys to select: <i>Ringing</i> .
<i>Beep</i>	Use up-down and "OK" navigation keys to select: <i>Beep</i> .
<i>Switch</i> or 	<ul style="list-style-type: none"> <i>0 Beep</i> A normal ring signals an incoming call. <i>1 Beep</i> A beep followed by the ring signals an incoming call. <i>3 Beep</i> Three beeps followed by the ring signals an incoming call.
 or <i>Save</i>	Validate your choice.
	End the procedure.

5.1.5 Configuring the seat mode

Your desk phone supports the seat mode, which is a different ring mode. The seat mode allows your administrator to switch the ringing onto the loudspeaker, the headset, or both. This feature can be configured on the Web Based Management page.



5.2 Selecting a language

When the desk phone is in idle state:

<i>Menu</i>	Press the Menu soft key to access the Main Menu.
<i>Basic Settings</i>	Use up-down and "OK" navigation keys to select: <i>Basic Setting</i> .
<i>Languages</i>	Use up-down and "OK" navigation keys to select: <i>Languages</i> .
<i>Switch</i> or 	Select the language of your choice.
 or <i>Save</i>	Validate your choice.
	End the procedure.



5.3 Adjusting the brightness of the desk phone

When the desk phone is in idle state:

<i>Menu</i>	Press the Menu soft key to access the Main Menu.
<i>Basic Settings</i>	Use up-down and "OK" navigation keys to select: <i>Basic Setting</i> .
<i>Display</i>	Use up-down and "OK" navigation keys to select: <i>Display</i> .
<i>Backlight</i>	Use up-down and "OK" navigation keys to select: <i>Backlight</i> .
Use left-right navigation keys to adjust the brightness.	
<i>Active Level</i>	Adjust the brightness when the desk phone is active.
<i>Inactive Level</i>	Adjust the brightness when the desk phone is inactive.
<i>Backlight Time</i>	Set the duration for the desk phone backlight.
<i>Switch</i> or 	Set the duration for the backlight.
 or <i>Save</i>	Validate your choice.
	End the procedure.



5.4 Enabling the Screen Saver and defining the Wait Time

When the desk phone is in idle state:

<i>Menu</i>	Press the Menu soft key to access the Main Menu.
<i>Basic Settings</i>	Use up-down and "OK" navigation keys to select: <i>Basic Setting</i> .
<i>Display</i>	Use up-down and "OK" navigation keys to select: <i>Display</i> .
<i>Screen Saver</i>	Use up-down and "OK" navigation keys to select: <i>Screen Saver</i> .
<i>Screen Saver</i>	Enable the Screen Saver and define the Wait Time (use left-right navigation keys).
<i>Wait Time</i>	Enter the wait time in seconds before the screen saver starts.
 or <i>Save</i>	Validate your choice.
	End the procedure.



5.5 Configuring the background picture for your H6 DeskPhone

When the H6 DeskPhone is in idle state:

<i>Menu</i>	Press the Menu soft key to access the Main Menu.
<i>Basic Settings</i>	Use up-down and "OK" navigation keys to select: <i>Basic Setting</i> .
<i>Display</i>	Use up-down and "OK" navigation keys to select: <i>Display</i> .
Set Background	Use up-down and "OK" navigation keys to select a picture as the homepage background.
Background Picture	The background picture can also be configured on the Web Management page.
 or <i>Save</i>	Validate your choice.
	End the procedure.



5.6 Configuring the homepage format

When the desk phone is in idle state:

<i>Menu</i>	Press the Menu soft key to access the Main Menu.
<i>Basic Settings</i>	Use up-down and "OK" navigation keys to select: <i>Basic Setting</i> .
<i>Display</i>	Use up-down and "OK" navigation keys to select: <i>Display</i> .
<i>Homepage</i>	Use left-right navigation keys or the Switch key to select a display mode for the homepage.
 or <i>Save</i>	Validate your choice.
	End the procedure.

5.7 Defining the voicemail number



When the desk phone is in idle state:

<i>Menu</i>	Press the Menu soft key to access the Main Menu.
<i>Voicemail</i>	Use up-down and "OK" navigation keys to select: <i>Voicemail</i> .
<i>Set Voicemail Number</i>	Use up-down and "OK" navigation keys to select: <i>Set Voicemail Number</i> .
	Enter the voicemail number of the corresponding account.
 or <i>Save</i>	Validate your choice.
	End the procedure.



5.8 Programmable keys

Depending on the desk phone model, you can program between 8 (for H3P/H3G) and 12 keys (for H6).

5.8.1 Creating a programmable key

	<p>Long press on a programmable key (on the right of the screen).</p>
 Switch	<p>Define the type of the programmable key. Depending on the type of the key, fill in the options.</p>
 or <i>Save</i>	<p>Save the programmable key.</p>

5.8.2 Deleting a programmable key

	<p>Long press on a programmable key (on the right of the screen).</p>
 Switch	<p><i>Use the left-right navigation keys to switch to the Undefined option.</i></p>
 or <i>Save</i>	<p>Save to delete the programmable key.</p>

5.8.3 Type of supported programmable keys

- *Undefined*: delete a programmable key.
- *Account*: line key.
 - *Account*: select the relevant SIP account.
 - *Label*: enter the label of the line key, displayed on the homepage.
- *Speed Dial*: speed dial key (direct call key).
 - *Account*: select the relevant SIP account.
 - *Label*: enter the label of the Speed Dial key, displayed on the homepage.
 - *Value*: enter the number you want to dial immediately.
- *BLF (Busy Lamp Field)*: indicates whether a specific account connected to the same system is busy or not. Use the BLF key to make a direct call or pick up a call.
 - *Account*: select the relevant SIP account.
 - *Label*: enter the label of the BLF key, displayed on the homepage.
 - *Value*: the number of the extension which the user wants to monitor.
 - *Extension*: a list of extensions which the user wants to monitor.
- *BLF List*: a list of extensions which the user wants to monitor. The list is defined by your administrator on the Web Management page or a configuration file.
 - *Account*: select a specific SIP account to monitor extensions of that account.
- *Hold*: place the current call on hold.
 - *Label*: enter the label of the Hold key, displayed on the homepage.
- *Transfer*: Transfer the current call.
 - *Label*: enter the label of the Transfer key, displayed on the homepage.
 - *Value*: the number to be transferred.

- *Conference*: conference call feature.
 - *Label*: enter the label of the Conf key, displayed on the homepage.
 - *Value*: the number of the caller who wants to initiate a conference call.
- *DND*: do not disturb feature.
 - *Label*: enter the label of the DND key, displayed on the homepage.
- *Redial*: redial the last outgoing number.
 - *Label*: enter the label of the Redial key, displayed on the homepage.
- *Directory*: local directory.
 - *Label*: enter the label of the Directory key, displayed on the homepage.
- *Forward*: immediate forward to a number.
 - *Label*: enter the label of the Forward key, displayed on the homepage.
 - *Value*: enter the destination number.
- *Voicemail*: connect to the voicemail to obtain voice messages.
 - *Account*: select the relevant SIP account.
 - *Label*: enter the label of the Voicemail key, displayed on the homepage.
 - *Value*: enter the voicemail prefix code.
- *Hot Desking*: desk sharing feature.
 - *Label*: enter the label of the Hot Desking key, displayed on the homepage.
- *Prefix*: enter the predefined prefix when you start dialing.
 - *Account*: select the relevant SIP account.
 - *Label*: enter the label of the Prefix key, displayed on the homepage.
 - *Value*: prefix.
- *DTMF*: send a predefined DTMF digits during conversation.
 - *Label*: enter the label of the DTMF key, displayed on the homepage.
 - *Value*: DTMF code.
- *DirectPickup*: call pickup.
 - *Account*: select the relevant SIP account.
 - *Label*: enter the label of the DirectPickup key, displayed on the homepage.
 - *Value*: enter the pickup code followed by the extension number.
- *GrpPickup*: group call pickup.
 - *Account*: select the relevant SIP account.
 - *Label*: enter the label of the GrpPickup key, displayed on the homepage.
 - *Value*: enter the group pickup code followed by the extension number.
- *Headset*: activate/deactivate the headset mode.
 - *Label*: enter the label of the Headset key, displayed on the homepage.
- *GroupListen*: activate/deactivate the group listening mode.
 - *Label*: enter the label of the GroupListen key, displayed on the homepage.
- *Intercom*: make a call to a contact who will automatically answer the call.
 - *Account*: select the relevant SIP account.
 - *Label*: enter the label of the Intercom key, displayed on the homepage.
 - *Value*: enter the contact number to call.
- *Audio Hub*: use your desk phone as an audio hub for your computer.
 - *Label*: enter the label of the Audio Hub key, displayed on the homepage.
- *XML Browser*: display an XML page.
 - *Label*: enter the label of the XML Browser key, displayed on the homepage.
 - *Value*: enter the URL of the XML page.

- *Phone Lock*: lock/unlock the phone.
 - *Label*: enter the label of the Phone Lock key, displayed on the homepage.
- *USB Record: record call conversations to USB disks*.
 - *Label*: enter the label of the key, displayed on the homepage.
 - This feature applies to only H6 DeskPhones.

Programmable keys can also be configured by the administrator on the Web Management page or via a configuration file.

LED behavior may differ depending on the desk phone configuration. You can design the types of programmable keys to meet requirements of different PBX, for example, Automatic Call Distribution (ACD) and Hoteling features. Specific configuration depends on the PBX requirements.

- For more information, contact your administrator.

5.9 Call pick-up

If authorized, you can answer calls of a specific account that no one answers on your own telephone.

The server can be configured to prevent call pick-up on some telephones.

Before using this feature, you must program a key on the homepage for the following feature: *DirectPickup* or *GrpPickup*

- If the phone ringing is in your own pick-up group, select the programmed key: *GrpPickup*
- If the phone ringing is not in your pick-up group, select the programmed key: *DirectPickup*

5.10 Activating the headset mode

You can use a headset with your desk phone. If you want the headset to ring only when receiving an incoming call, you must activate the headset mode.

Before using this feature, you must press the headset key to activate the headset feature. When the feature is activated, the LED of the headset is on and shows a blue light.

When the desk phone is in idle state:

Connect the headset to the desk phone





Press the *Headset* key.

This icon is displayed on your desk phone screen: 

5.11 Defining Time and Date format

When the desk phone is in idle state:

<i>Menu</i>	Press the Menu soft key to access the Main Menu.
<i>Basic Settings</i>	Use up-down and "OK" navigation keys to select: <i>Basic Setting</i> .
<i>Time and Date</i>	Use up-down and "OK" navigation keys to select: <i>Time & Date</i> .
	<i>Date: use the left-right navigation keys to select a date format. There are 6 date formats: YY-MM-DD, YYYY/MM/DD, YY/MM/DD, YYYY MM DD, YYYY-MM-DD, and MM DD WW</i>
	<i>Time: use the left-right navigation keys to select a time format. There are two time formats: 12-hour clock and 24-hour clock.</i>
 or <i>Save</i>	Validate your choice.

6 Contacting your administrator (technical support)

If necessary, you may need to contact your administrator.
Before contacting your administrator, make sure you have information such as your desk phone's codes and software version.

6.1 Technical code / Date code

The codes are located on the back shell. This label is an example and does not represent the one placed on your desk phone.

- 1 Technical code (ordering code)
MAC information and date code



6.2 Viewing the software version/network settings (IP address)

The software version can be viewed on the phone by using the following methods:

When the desk phone is in idle state:

Use one of the following methods:

	Display the current IP and MAC addresses and software version of the desk phone.
<i>Menu → Status</i>	Display the current IP and MAC addresses and software version of the desk phone.

6.3 Accessing administrator configuration

6.3.1 Default password

The default password for the advanced settings of the desk phone is "123456".

The default user name and password for accessing the Web Based Management is "admin" and "123456".

When connecting for the first time, the desk phone will prompt the user to modify the default password.

6.3.2 Advanced Settings

When the desk phone is in idle state:

<i>Menu</i>	Press the Menu soft key to access the Main Menu.
<i>Advanced Settings</i>	Use up-down and "OK" navigation keys to select: <i>Advanced Setting</i> .
<i><123></i>	Enter the administrator password.
	The Advanced Setting menu allows the administrator to set SIP accounts, configure wireless networks, configure automatic deployment, change the password, and view IP parameters and certificates. The administrator can also restore factory settings of the desk phone by using that menu.

6.3.3 Web Based Management (WBM)

Web Based Management offers the administrator an easy way to configure the settings of your desk phone. Through a web based management service hosted by your desk phone, the administrator can manage and configure your phone.

When your desk phone is connected to the network, the administrator can access the Web Based Management via a web browser by entering the IP address of the phone.

Through the Web Based Management, your administrator can configure all SIP accounts of the desk phone.

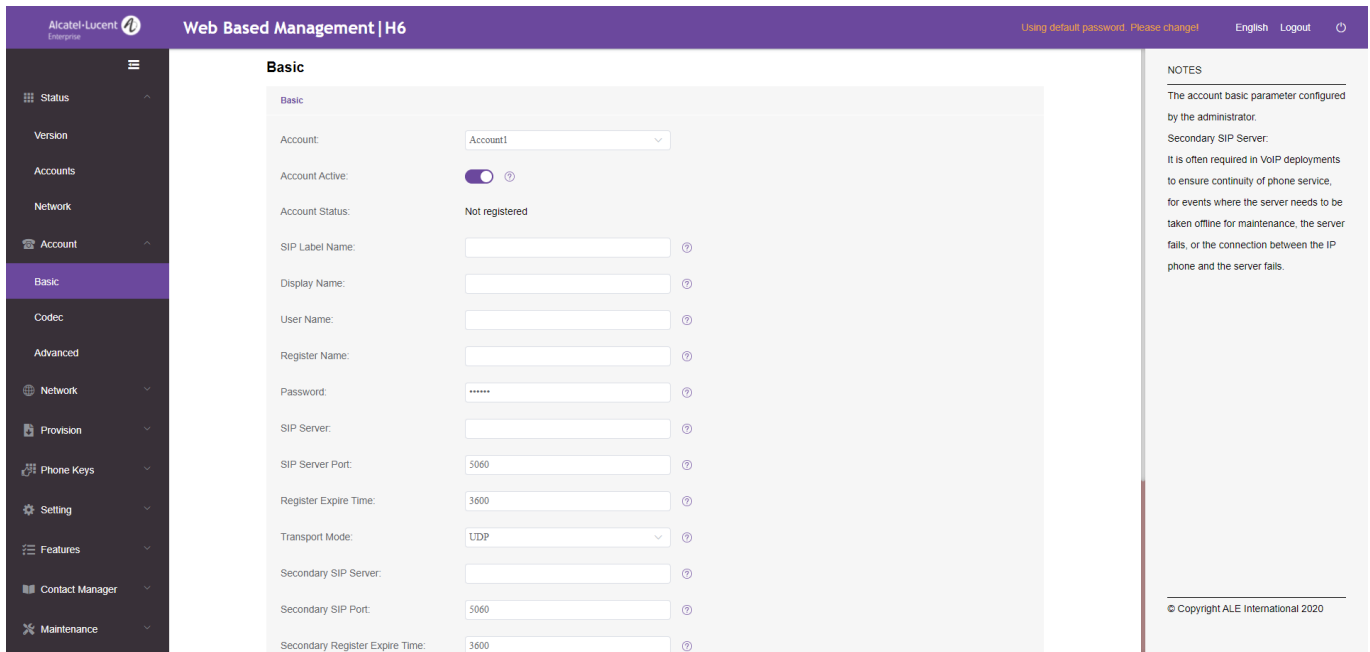

The administrator can also define the programmable keys and dynamic programmable keys displayed on the homepage.

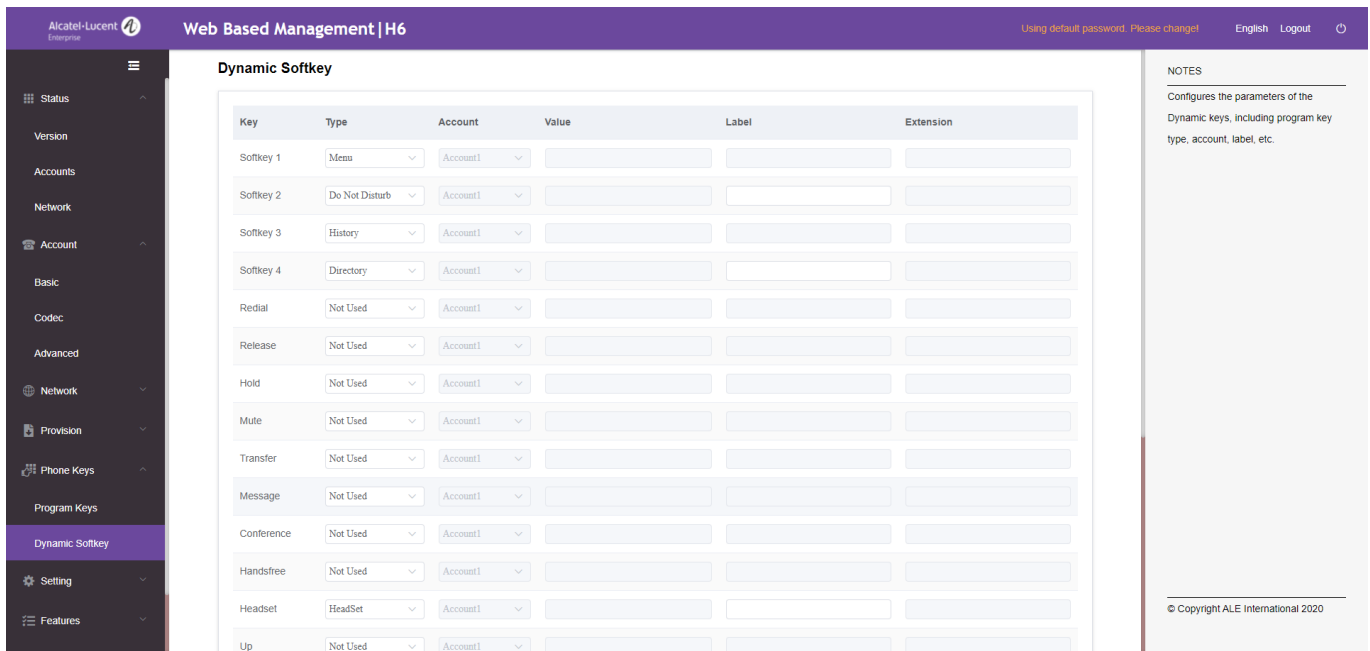

All configuration parameters of the desk phone can be managed on the Web Management page.

- Audio (ringing, dial tone...)
- Backlight, Screen Saver, Auto Lock
- Date Format, Time Format
- Call Forward, DND
- Hotline
- Intercom
- Programmable keys

- Network Configuration (DM, DNS, Ethernet, IP param, LDAP...)
- VPN Configuration
- Wallpaper (H6)
- ...

7 Accessories

The ALE-supported accessories are validated to work smoothly on our clients (hardphones, softphones). The list of accessories presented in this document is not contractually binding and can be modified without prior notice.

7.1 Headset

You can use an ALE RJ9 headset to handle calls on H3P / H3G / H6 or a USB headset to handle calls on H6. Unlisted USB headsets may not work properly if you connect them to your phone. To know more information about headsets, please contact your administrator or refer to the Alcatel-Lucent Enterprise website. The following headsets have gone through stringent tests and are compatible with H3P / H3G / H6:

RJ9 headset	Alcatel-Lucent Enterprise AH 11 GA HEADSET MONAURAL RJ9
	Alcatel-Lucent Enterprise AH 12 GA HEADSET BINAURAL RJ9
USB headset	Alcatel-Lucent Enterprise AH 11 U HEADSET MONAURAL USB-A
	Alcatel-Lucent Enterprise AH 12 U HEADSET BINAURAL USB-A
	Alcatel-Lucent Enterprise AH 21 U PREMIUM HEADSET MONAURAL USB-A
	Alcatel-Lucent Enterprise AH 22 U PREMIUM HEADSET BINAURAL USB-A
	Alcatel-Lucent Enterprise AH 22 M PREMIUM HEADSET BINAURAL USB-A

7.2 USB Wi-Fi adapter

Currently, H6 DeskPhone supports Tenda U3/U9 wireless adapter. To know more about wireless adapters, please contact your administrator or refer to the Alcatel-Lucent Enterprise website.

7.3 Wall mount

To mount your phone on the wall, you need to install a standard wall plate that you can easily find on the market. Follow the manufacturer's instructions to install the wall plate on the wall. When the wall plate is fixed, you can prepare your phone and mount it on the wall. The wall mount kit is sold separately (refer to the chapter about ordering information for reference).

- 1** Firmly attach the wall mount kit to the back of the phone by using the two screws provided.

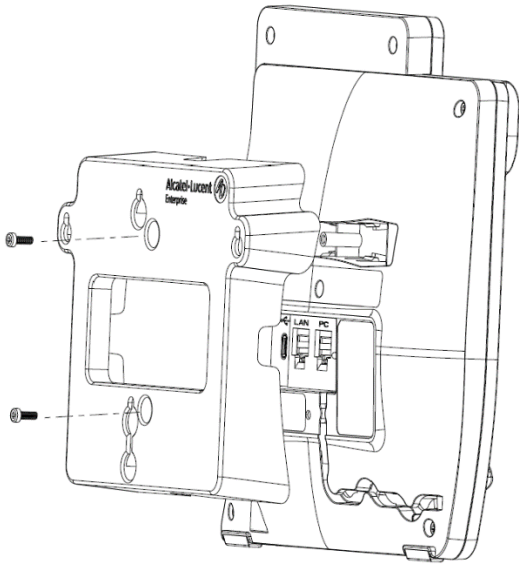

- 2** Hang the assembled phone with the wall mount kit on the wall plate.

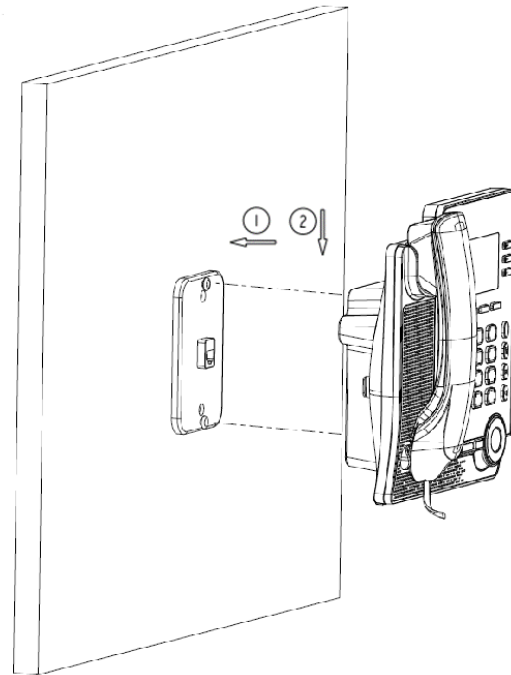

8 Technical specifications

	H3P DeskPhone	H3G DeskPhone	H6 DeskPhone
Width	214 mm	214 mm	214 mm
Length	191 mm	191 mm	191 mm
Height	47 mm	47 mm	47 mm
Weight	795 g	795 g	805 g
Angle of the support foot	45° / 50°	45° / 50°	45° / 50°
Color	Gray	Gray	Gray
Display	2.8-inch monochrome display with backlight, 132 × 64 pixels	2.8-inch monochrome display with backlight, 132 × 64 pixels	2.8-inch color display, 320 × 24 pixels
Line key	3	3	4
Headset interface	RJ9	RJ9	RJ9/USB Type A
Ethernet ports	Dual 100 Mbps Ethernet ports	Dual 1000 Mbps Ethernet ports	Dual 1000 Mbps Ethernet ports
Power over Ethernet (IEEE 802.3af)	Class 1	Class 1	Class 2
External power supply (accessory)	5V/2A	5V/2A	5V/2A
Working temperature	-5°C to +45°C	-5°C to +45°C	-5°C to +45°C

9 Ordering information

H3P DeskPhone	3MK27010AA
H3G DeskPhone	3MK27011AA
H6 DeskPhone	3MK27012AA
H3P/H3G/H6 Wall Mounting Kit	3MK27015AA
H3P/H3G/H6 Power Supply Europe	3MK37001AA
H3P/H3G/H6 Power Supply US	3MK37001US
H3P/H3G/H6 Power Supply UK	3MK37001UK
H3P/H3G/H6 Power Supply AU	3MK37001AU

10 Guarantee and clauses

10.1 Safety instructions

- Without explicit authorization from the party responsible for compliance, users have no permission to operate the equipment and make changes or modifications to the equipment.
- Keep a safe distance between your pacemaker or implant defibrillator and the handset which includes magnetic elements: 4 centimeters (1.6 inches) at least.
- To limit the risk of interference, people with pacemakers must keep the wireless telephone away from their equipment (minimum distance of 15 cm/6 inches).
- It is recommended to follow the standard acceptance procedures before using this equipment in human safety critical areas (hospitals...).
- The handset includes magnetic elements that may attract sharp metallic objects. To prevent injury, before each use, ensure sharp metallic objects are not stuck to the earpiece and microphone.
- Avoid using phones (except for cordless type) during an electrical storm. There may be a remote risk of electric shock from lightning.
- Do not use this device in environments where there is a danger of explosion.
- Do not plug this phone into an Integrated Services Digital Network (ISDN) connection or into a regular Public Switched Telephone Network (PSTN) connection. This can result in severe damage to the phone.
- Never allow your desk phone to come into contact with water.
- To clean your phone, use a soft damp cloth. Never use solvents (such as trichloroethylene and acetone) which may damage the plastic parts of your desk phone. Do not use aerosol cleaners.
- H3P / H3G / H6 DeskPhone: this product is intended to be supplied, either via an Ethernet (LAN) port, or via a DC-in interface by a Certified Direct Plug-In Power Unit approved as 'FRECOM' (Limited Power Source) against CSA/UL/IEC 60950-1. The power unit must have a rated voltage of 5V DC and the current of minimum 2A. Allowed power supply is: F12L20-050200SPAC
- If you are connected to a POE connection, do not use an external power supply.
- The PoE (Power over Ethernet) devices that supply or receive power and their connected cables must all be completely indoors.

ALE Legal Notice:

www.al-enterprise.com

The Alcatel-Lucent name and logo are trademarks of Nokia used under license by ALE. To view other trademarks used by affiliated companies of ALE Holding, visit: www.al-enterprise.com/en/legal/trademarks-copyright.

All other trademarks are the property of their respective owners. The information presented is subject to change without notice. Neither ALE Holding nor any of its affiliates assumes any responsibility for inaccuracies contained herein.

© Copyright 2021 ALE International, ALE USA Inc. All rights reserved in all countries.

Main screen



Soft keys	4 soft keys under the screen are used to access features, configure the phone, or manage calls. Press the soft keys under the screen to access features. Use the up-down navigation keys to navigate through the menus and to select an entry or an option.
Programmable keys	2 programmable keys (3 for H6) on the right of the screen are used to customize different features of the desk phone. Press the programmed key to use the programmed feature (for example, call contacts). Long press the programmed key to enter into the key configuration. Line keys on the right of the screen can be associated with SIP accounts (optional).
Line keys	Press the line key associated with an SIP account to make a call or to answer an incoming call to this account.
Turn pages	1234 on the lower right of the screen are used for turning pages (a total of 4 pages). Use the left-right navigation keys or the "1234" programmed key to navigate between pages. The number of the displayed page is highlighted.
Status bar	Display the desk phone status information including the desk phone network status and desk phone status on the upper part of the screen.
Date and time	Date, time, and status bar on the left of the screen.
OK key	Use this key to validate your choices while programming or configuring (short press).
left-right navigation key	used to move from one page to another or to move the cursor in a text box.
up-down navigation key	used to select an option from a list.
C key	Back/Exit key: Use this key to go back to the previous step.
NOTE	The figures above are main screens of H6, and H3P/H3G, respectively.

Call management screen

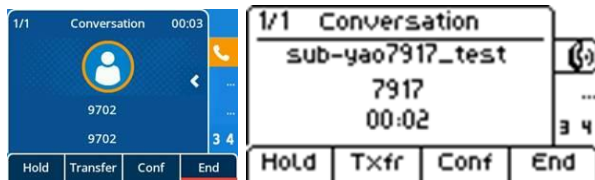

Soft keys	Soft keys on the lower part of the screen display different features available depending on the call status. Press the soft key to select the corresponding feature.
Call display screen	Call information such as the duration, number, and caller name is displayed in the middle of the screen.

Function Keys

	Take/redial the call key Display the dialing list, enter the dialing page, and select the last number dialed.
	Place a call on hold/recover the call
	Transfer a call
	Start a conference call with contacts and add participants to a conference call
	Switch off ringer Hook on Go back to the homepage
	Mute key During a call, press this key to stop your contact from hearing you. When activated, the key is lit red.
	Access the voicemail The message key flashes red when you have received a new voice message or missed an incoming call.
	Press this key to open the dialer (idle state) in handsfree mode.
	Press this key to answer an incoming call in handsfree mode (idle state). The key is lit blue. When a call is in progress, pressing this key switches from handsfree mode to headset or handset mode. Hang up in handsfree mode.
	Decrease the volume of the ring tone (9 steps) in idle state or when you receive an incoming call. Decrease the volume of the handset, loudspeaker or headset (7 steps) during a conversation.
	Increase the volume of the ring tone (9 steps) in idle state or when you receive an incoming call. Increase the volume of the handset, loudspeaker or headset (7 steps) during a conversation.

Icon

Icons giving information about some specific configurations of the phone or about call status are displayed in the top status bar of the screen.

	SIP account (idle state). A grayed or crossed icon means that the SIP account is not registered (Please contact your administrator). Line keys
	Incoming call icon
	Call in progress icon
	Call on hold icon





Alpha-numeric dialpad

Your phone is equipped with an alphanumeric dialpad.

	When you are in a text zone, you can switch to the alphabetic dialpad by using this key.
	When the alphabetic dialpad is activated, select this key to switch to the numeric dialpad.

Enter alphabetic characters.

The number pad keys have letters that you can display by successive presses. The number is the last character in the series. Some special characters can be displayed by successively pressing the key:

	% \$ / ~ & () [] = *
	@ #
	space - _ 1
	+ . , ; : \ ? ! 0

Contacts management

<i>Directory</i>	Select this soft key to open contacts management.
<i>Add</i>	Create a contact.
<i>Bkspc</i>	Delete the selected contact.
<i>More</i>	Access more features.
<i>Call</i>	Call the selected contact.
<i>Detail</i>	Open the contact card.
<i>Delete all</i>	Delete all contacts in the local directory.
<i>AddGrp</i>	Add a group.
<i>Enter</i>	List all contacts in the selected group.
<i>Back</i>	Return to the homepage.





Contact card

<i>Directory</i>	Select this soft key to open contacts management.
<i>Detail</i>	Open the contact card. Modify a contact.
<i>Back</i>	Return to the homepage.





Manage the call log (history)

<i>History</i>	Access the call log.
<i>Bkspc</i>	Delete the selected entry. Note that no secondary confirmation is requested.
<i>Call</i>	Call the selected contact.
<i>More</i>	Access more features.
 <i>or details</i>	Open the information about the contact: name, number, time, relevant SIP account, and call duration
<i>Delete all</i>	Delete the entire log associated with the selected contact.
<i>AddClst</i>	Add the contact to your local directory. If the contact already exists, the contact card is updated.
<i>Back</i>	Return to the homepage.

Making a call

	Select the SIP account to use to make a call. A dial area and the list of last number dialed are displayed.
	Enter the number
<i>abc</i> 	Call by name
<i>History</i>	Call from call log
<i>Directory</i>	Call using your local directory
Use one of the following methods:	
	Press the Redial key. Make the call with the active device: handset if unhooked, headset if connected, otherwise in handsfree mode
	Press the OK key to start the call. Make the call with the active device: handset if unhooked, headset if connected, otherwise in handsfree mode
<i>Call</i>	Press the Call key to start the call. Make the call with the active device: handset if unhooked, headset if connected, otherwise in handsfree mode
<i># or *</i>	If defined in the phone settings, you can use these keys to initiate the call (<i>Menu → Features → Key As Send</i>)



Receiving a call

	Lift the handset to take the call.
	Use the headset to take the call. If your headset has no off-hook/on-hook key, use the phone keys to control  .
	Press the Loudspeaker/Handsfree key to take the call in handsfree mode.
	Press the blinking line key associated with the SIP account.
<i>Take call</i> or 	Take the call with the headset if connected, or in handsfree mode.
 <i>or Reject call</i>	Transfer the call to your voicemail.
<i>Forward</i>	Transfer the call to another contact.

During conversation

<i>End</i>	End the call
<i>Hold</i>	Call holding
<i>Transfer</i>	Call Forward
<i>Resume</i>	Retrieve a call (on hold, parked).
<i>New</i>	Make a second call during a conversation.
<i>Swap</i>	Switch between calls.
<i>Conf</i>	Establish a three-party conference call.
<i>End conf</i>	End the conference with all participants
	Mute/unmute the selected participant

Settings

<i>Menu</i>	Press the soft key settings.
<i>Basic Setting</i> → <i>Sound</i> → <i>Ringin</i>	Select the melody Adjust the ringer volume Configuring the ring mode Configuring the beep mode
<i>Basic Setting</i> → <i>Sound</i> → <i>DTMF Tone</i>	To activate or deactivate the DTMF mode.
 	Adjust the ringer volume
<i>Basic Setting</i> → <i>Language</i>	Selecting a language
<i>Basic Setting</i> → <i>Display</i>	Adjust the brightness when the phone is in use. Adjust the brightness when the phone is not in use. Set the delay before the screen saver starts.
<i>Status</i>	Display IP and MAC addresses and software version.
<i>Features</i>	Access phone features: Call Forward, DND, Auto Answer, Programmable Key, Anonymous, Key As Send, Hotline, Default Account, Intercom.
<i>Voicemail</i>	Define a voicemail number Access the voicemail